

Overview and Quick Start

Device layout

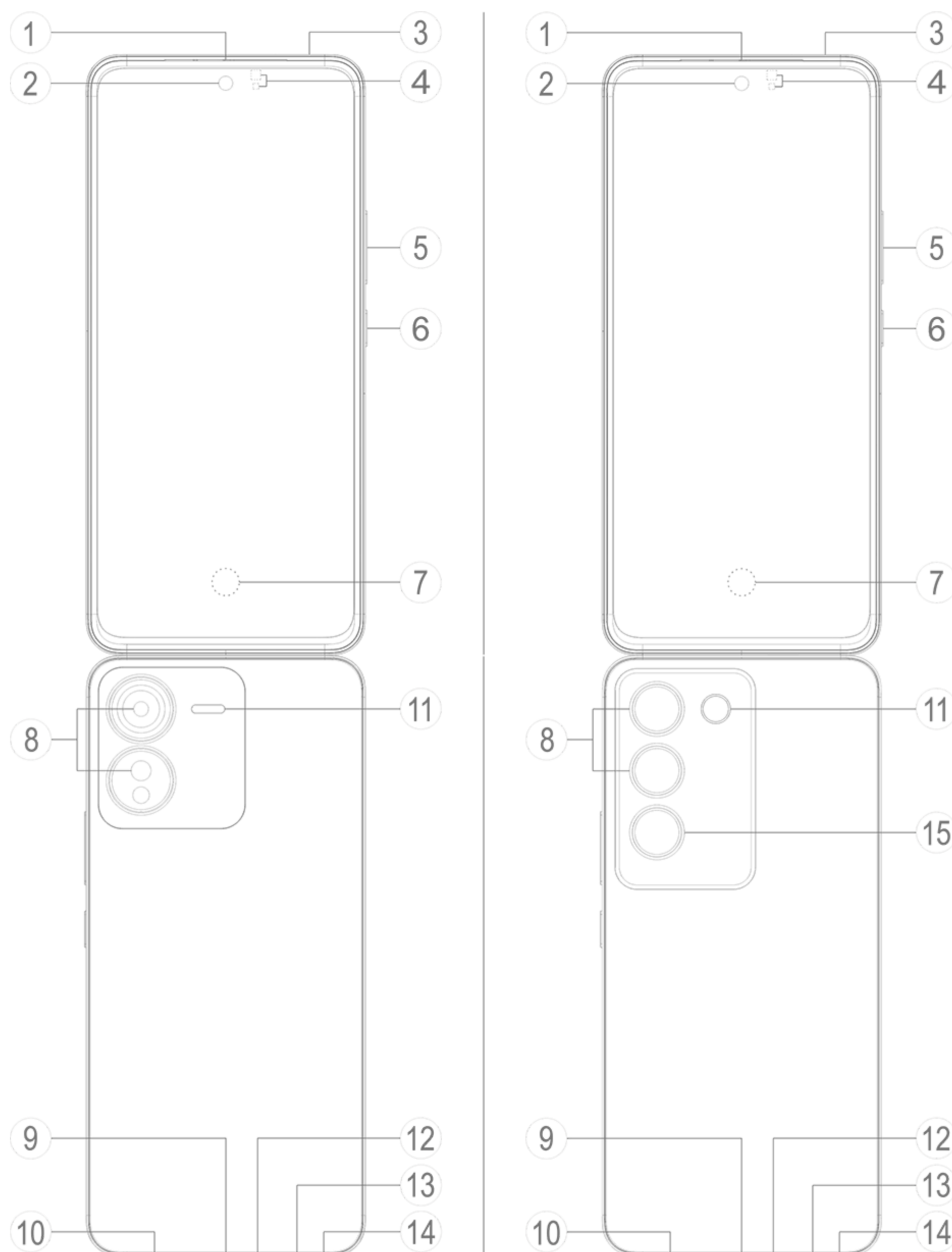

Note

The illustrations in the Manual are for reference only. Options may vary by device model.

Buttons and components

1. **④ Ambient light sensor & Proximity sensor:** The ambient light sensor automatically detects the intensity of the ambient light, and adjusts the screen brightness accordingly, ensuring a user-friendly experience.

The proximity sensor automatically detects the distance between you and your phone when you make or answer a call. If you are too close to your phone, the screen will turn off to prevent accidental touches. The proximity sensor doesn't work in earphone or speaker mode.

2. **⑤ Volume buttons:** Adjust the volume.

3. ② **Front camera**/⑧ **Rear camera**: Take photos or record videos.
4. ① **Receiver and speaker**: Play audio during a call. Play sound
5. ⑥ **Power button**: Press and hold the button to power on or off your phone.

Note

When your phone can't work properly, press and hold the Power button and Volume down button for at least 10 seconds to force restart it.

6. ⑦ **Fingerprint sensor**: Identifies your fingerprints, enabling you to unlock your phone without a password.
7. ⑬ **SIM card tray**: Used to insert or remove the SIM card.
8. ⑭ **SIM card eject hole**: Insert an eject pin into the hole, push it all the way into the hole until the tray ejects, and then pull the tray out.
9. ⑫ **Main microphone**/③ **Secondary microphone**: Used to transfer sound during a call.
10. ⑪ **Flash**: Produces a brief burst of light.
11. ⑩ **Speaker**: Used to play audio.
12. ⑨ **USB port**: A standardized interface for connecting your device to earphones, charger, computer, or other compatible device.
13. ⑮ **Flicker sensor**: Assists in fine-tuning photo effects.

Set up and get started

Insert a SIM card

 **Note: Depending on your region or carrier, you may get a single or dual SIM phone, but the differences between the two versions are not fully covered in the Manual. The illustrations in the Manual are for reference only. Options may vary by device model.**

You can insert a nano-SIM card (SIM 1 or SIM 2) with no need to turn your device off. When turned on, it will automatically identify whether you have inserted a nano-SIM card (SIM 1 or SIM 2). Your device uses nano-SIM cards (SIM 1 or SIM 2).

1. Insert an eject pin into the hole, push it all the way into the hole until the tray ejects, and then pull the tray out.

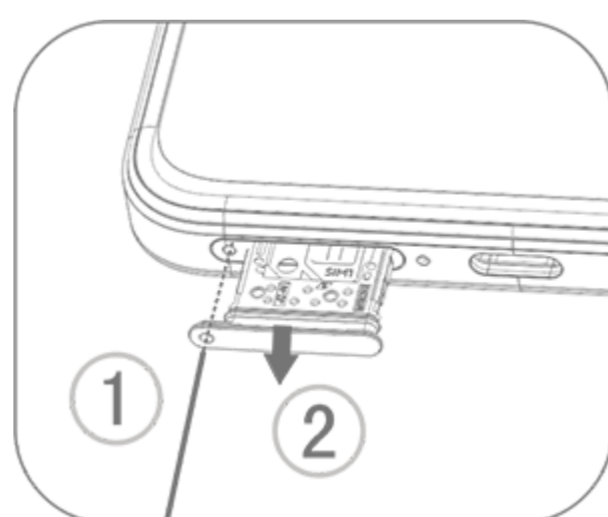

2. Place your nano-SIM card into the SIM 1 or SIM 2 holder in the direction of the arrow as shown in the illustration. Make sure to align the angled corner to the notch on the holder.

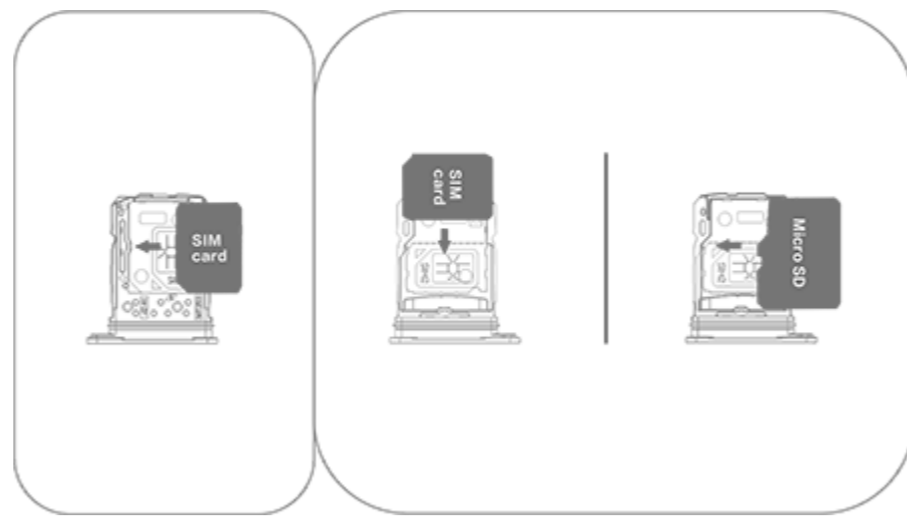

3. Hold your device face up, and then slide the tray all the way into the slot in the direction as indicated by the arrow.

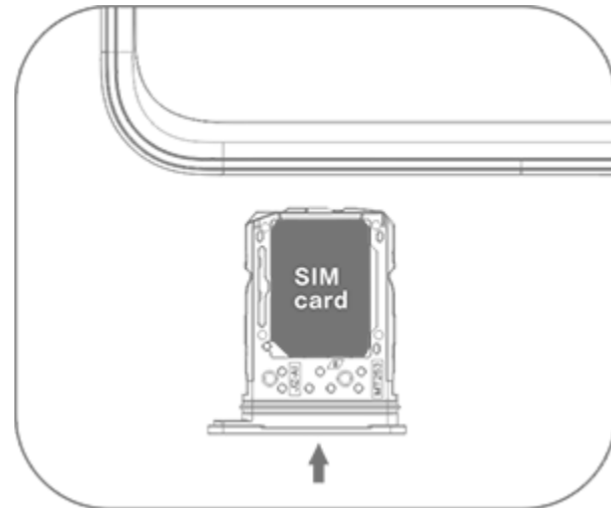

Note

1. Do not remove the back cover to avoid damaging your device.
2. Do not insert the nano-SIM card (SIM 1 or SIM 2) directly into the slot of your phone.
3. Trying to trim the nano-SIM card yourself may lead to card damage or cause serious damage to your device. If the nano-SIM card (SIM 1 or SIM 2) doesn't match your device, go to your carrier and request a replacement with a standard-sized card.
4. Your device adopts a dual-SIM dual-standby single-pass solution, which means you can't use both SIM cards for calls or data services simultaneously.
 - During a call made with one SIM card, the other SIM card will be temporarily disabled. If someone makes a call to this line, they will hear prompts, such as "The number you have dialed is not in service" or "The subscriber you have dialed is not available. Please try again later".
 - When one SIM card is connected to the data network, the other SIM card is unable to access data services.This is caused by the device design and has nothing to do with the carrier's network conditions. By using a single chip in your device, this design greatly enhances battery life and minimizes power consumption. To receive reminders for missed calls, contact your carrier to enable missed call notifications, incoming call notifications, and secretary services.

Antenna

Your device is equipped with a built-in antenna.

Don't touch the antenna when it is transmitting or receiving signals. Touching the antenna may compromise the communications quality, cause your device to function at an unnecessarily high power level, as well as shorten the battery life.

The antenna is located inside the area marked with dotted lines as shown in the illustration below. Don't cover this area when holding your device.

- A. GPS/Wi-Fi/Communications antenna.
- B. Communications antenna.

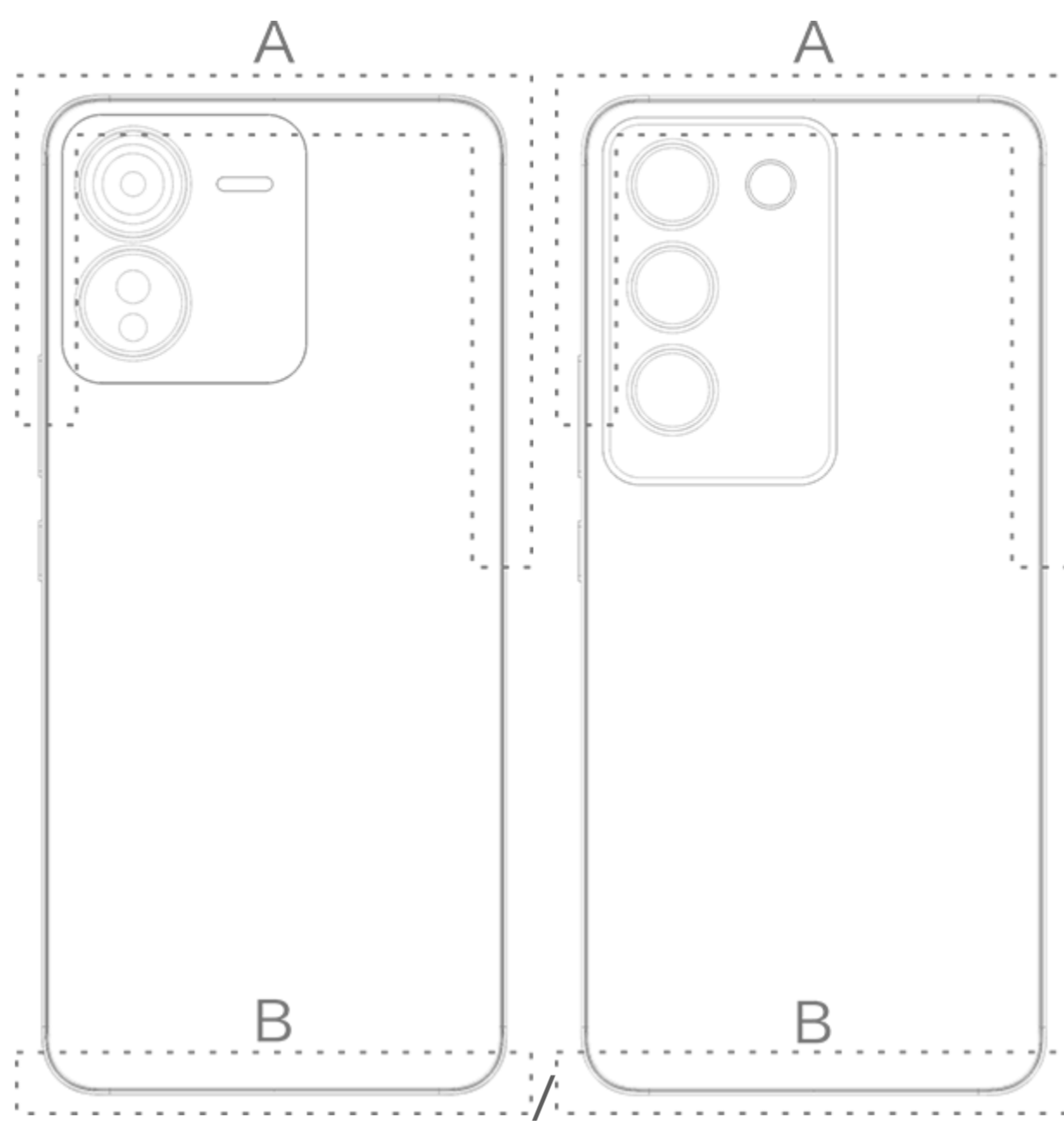

⚠️ Note



The illustrations in the Manual are for reference only. Options may vary by device model.

Basic gestures

Get familiar with basic gestures to interact with your device better.









Basic gestures













	Tap the screen
	Swipe up
	Swipe down
	Swipe right

	Swipe left
	Pinch in on the screen
	Pinch out on the screen

Status icons

Status icons appear in the status bar at the top of the screen. See the table below for common status icons and their meanings.

	Signal strength
	No signal
	Airplane mode on
	Wi-Fi on
2G/G/E	2G on
3G/H/H+	3G on
4G/4G+	4G on
5G	5G on
LTE/LTE+	LTE on
	Bluetooth device connected
	Vibration mode on
	Silent mode on
	Do Not Disturb on

	New message
	Missed call
	Alarm on
	Battery level
	Charging
	Data Saver
	Hotspot on
	Location on
	VPN connected
	Screen Mirroring on
	Record screen on
	Earphones connected

Note

1. The network symbols may differ depending on your carrier and network settings.
2. The icons may vary by device model. The status icons in the above table are for reference only.
3. The 5G icon is for illustrative purposes only and will only be visible on 5G-capable devices.

Turn on or off your device

Turn off your device

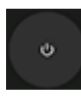
To turn off your device, press and hold the Power button and Volume up button simultaneously, and tap .

Turn on your device

To turn on your device, press and hold the Power button until your device vibrates.

Note

When your device is very low on power, it will display an image of a nearly depleted battery. Charge your device to use it.

Restart your device

To restart your device, press and hold the Power button and Volume up button simultaneously, and tap .

Force restart your device

Press and hold the Power button and Volume down button simultaneously for at least 10 seconds to force restart your device.

Charge your device

When the battery is running low, you will be prompted to charge your device.

Charge via a USB cable

To charge your device via a charger and a USB cable:

1. Connect the charger to your device via a USB cable.
2. Plug the charger into a power outlet.
3. Disconnect the charger when your device is fully charged.

Note

To ensure charging safety, use the charger and USB cable compatible with your device.

Charge with a wireless charger

To charge your device wirelessly:

1. Place your device on the center of the wireless charger with the screen facing upwards.
2. Plug the charger into a power outlet.
3. Disconnect the charger when your device is fully charged.

Note

This feature is only available on devices that support wireless charging.

Connect to earphones

You can connect earphones to your device to listen to music or watch movies in private.

Connect to wireless earphones

Method:

1. Start wireless earphones and make sure that they are detectable.
2. Use your device to search for and pair with the earphones in the following way:
 - 2.1 Go to **Settings > Bluetooth & devices > Bluetooth** to enable this feature.
 - 2.2 On the **Pair new device** screen, tap the name of the earphones to be paired with your device.
 - 2.3 Perform operations as prompted on the screen.
3. After the earphones are connected, they are displayed on the **Bluetooth** screen.

Note

The steps may vary depending on the earphones. Refer to the earphone manual for details.

Connect to wired earphones

Method:

Plug the earphones directly into the earphone jack and ensure they are securely plugged in.

Note

Some devices have a combined USB and earphone jack.

Adjust the volume

When you make or answer calls or stream multimedia files on your device, you can use the side buttons to turn the volume up or down.

Press and hold the volume buttons to adjust the volume

When you stream multimedia files on your device, press the Volume up or down button to turn the volume up or down.

Quickly mute your device

- When your device rings for an incoming call or alarm, press and hold the Volume down button to quickly mute it.
- When there is an incoming call, flip your device to quickly mute it.

Select a language

Select a language during the setup

When you turn on your device for the first time, you can select a language from the setup wizard based on your preferences. Method:

1. Tap .
2. Select a language.
3. Tap **Start**.

Set the system language and region

When you are on a trip or have relocated to a different area and want to change the language or region, go to **Settings > System > Languages & input**.

· To change the system language:

1. Tap **Language > +**.
2. Select the language you want to add.
3. Tap and hold **=** next to any language, and drag it to the top of the list.
4. To remove a language from the list, tap **Language > ⋮ > Remove** to select the language, and then tap .

Note

To remove a language, make sure there are at least two languages in the list.

· To change the language for a certain app:

1. Tap **App language**.
2. Tap the app for which you want to change language.
3. Select a language from the language list.

Note

This feature is available only for apps that support language selection.

· To change to a different region:

1. Tap **Region**.
2. Enter the region you want to change to in the search bar.
3. Select a region from the region list.

Connect to the internet

You can connect your device to a Wi-Fi network or mobile network.

Connect to Wi-Fi

Method:

1. Enable Wi-Fi in the following ways:

· Swipe down from the top of the screen to open the Control center, and tap  .

· Go to **Settings > Network & internet**, and enable **Wi-Fi**.

2. Go to the **Wi-Fi** screen, and tap a network to connect to it.

 indicates a Wi-Fi password is required.

Connect to mobile data

Method:

- Swipe down from the top of the screen to open the Control center, and tap  .
- Go to **Settings > Network & internet > SIM card & mobile network**, and enable **Mobile data**.

Note

1. After Mobile data is enabled, you can access apps that require an internet connection such as Browser and Email over the mobile network.
2. Charges may apply. For details, contact your carrier.

Transfer files

Clone data from your old phone to a new one

To do so, go to  **EasyShare > Phone clone**

Phone clone allows you to migrate data from your old phone to a new one without consuming any data.

• On the old phone:

1. Tap  .
2. Generate a QR code.
3. Display the QR code to the new phone for it to scan so as to pair up with the old phone.
4. Select the files you want to clone.
5. Tap **Start cloning**.

• On the new phone:

1. Tap .
2. Select the type of the old phone (iPhone or Android).
3. Scan the QR code to connect to the old phone.
4. Receive files.

Note

1. This is an overview of EasyShare features. For more information, go to **Apps > EasyShare** in the Manual.
2. If the old phone is an iPhone, make sure EasyShare has been installed before transferring files.
3. When file transfer is complete, the data of the same apps on the new phone will be overwritten.

Send or receive files wirelessly

To do so, go to  **EasyShare > File transfer**

Take Android-powered devices for example:

• **On the sending device:**

1. Tap .
2. Select files.
3. Generate a QR code.
4. Display the QR code to the receiving device for it to scan so as to pair up with the sending device.
5. Tap **Send**.

• **On the receiving device:**

1. Tap  on the main screen.
2. Scan the QR code on the sending device to connect to it.
3. Receive files.

Note

This is an overview of EasyShare features. For more information, go to **Apps > EasyShare** in the Manual.

Transfer files between your computer and phone with a USB cable

• **Connect your phone to a Windows computer with a USB cable**

Method:

1. Connect your phone to your computer with a USB cable.
2. Pull down the notification bar on your phone.
3. Tap the "Charging this device via USB" notification.
4. Select **File transfer**.
5. Double-click on "This PC" on your computer to view the connected device.
6. Double-click to access the device and copy or manage files on your phone.

Note

1. To ensure the proper functioning of this feature, it is necessary to install Windows Media Player 11 or a higher version on Windows XP computers. This is not a prerequisite for Windows 7 or newer operating systems.
2. The button name may vary by computer.

• **Connect your phone to a Mac computer with a USB cable**

Method:



1. Connect your phone to your computer with a USB cable.
2. Download the MTP tool on your computer.
3. Locate AndroidFileTransfer.dmg and double-click to open it.
4. Double-click the Android robot icon.
5. Copy or manage files on your phone.

Accounts

You need to sign in to your account to use some services.

Sign in to your account

1. Sign in to your account in either of the following ways:

- Go to **Settings** or **Settings > Accounts**, and tap  to sign in to your account.
- Go to **Settings > Accounts**, and tap  >  to sign in to your Google account.

2. Modify your profile or link the account to an email address.

Add an account

Go to **Settings > Accounts**, tap  to select an account type, and follow the on-screen instructions to add the account.

Note

You must connect your device to the internet to use this feature.

Set up system navigation modes

Gesture navigation

To return to the previous screen, go back to the home screen, and switch between open apps with gestures, go to **Settings > System > System navigation**, and select **Gesture navigation**.

Do any of the following as needed:

- To return to the previous screen: Swipe inward from the left or right edge of the screen.
- To go back to the home screen: Swipe up from the bottom of the screen.
- To access the Recent apps screen: Swipe up from the bottom and hold.
- To close a background app: Go to the Recent apps screen, and tap .





Note

When an app is locked, tapping  won't close it.

"3-button" navigation

To return to the previous screen, go back to the home screen, and switch between open apps with buttons, go to **Settings > System > System navigation**, and select **"3-button" navigation**.

Do any of the following as needed:

-  / : Return to the previous screen.
- : Go back to the home screen.
-  / : Access the Recent apps screen.

Change UI colors

You can change the UI color of your device.

Method:

1. Go to **Settings > Lock screen & wallpaper > Color and style** and enable **System and app UI color**.
2. Select a preset color or select a color from the wallpaper.
3. To restore the default color of the system and apps, disable **System and app UI color**.

Note

All illustrations in this Manual show the default UI colors of the device with **System and app UI color** disabled. The illustrations are for reference only. The UI colors may be different on specific devices.

Change the wallpaper

You can change the theme or wallpaper of your device.

Change the theme

Method:



1. Go to **Settings > Lock screen & wallpaper > Theme**.
2. Select a theme.

Change the wallpaper

Method 1:

1. Go to **Settings > Lock screen & wallpaper > Wallpaper**.
2. Do any of the following:
 - Select a preloaded wallpaper.
 - Go to **Static wallpapers > Local images** to select an image as your wallpaper.

Method 2:



1. Go to  **Albums** and select an image you like.
2. Open the image in full screen and tap  > **Set as wallpaper**.

Adjust the screen brightness and fonts

Adjust the screen brightness

• Manually adjust the screen brightness

To manually adjust the screen brightness:

- Swipe down from the top of the screen to open the Control center, and drag .
- Go to **Settings > Display & brightness**, and drag .

• Automatically adjust the screen brightness

To automatically adjust the screen brightness:

- Swipe down from the top of the screen to open the Control center, and tap .
- Go to **Settings** > **Display & brightness**, and tap **Adaptive brightness**.

Adjust the font size and style

• Adjust fonts:

Method:

1. Go to **Settings** > **Display & brightness** > **Font & display size**.

2. Do any of the following:

- To enlarge or reduce the font size, drag  under **Font size**.
- To enlarge or reduce the size of displayed content, drag  under **Display size**.
- To make all fonts appear with bold weight, tap **Bold font**.

• Change the font style

Method:

1. Go to **Settings** > **Display & brightness** > **Font style**.

2. Do the following:

- Select a preloaded style.
- Tap **Download more** to download a preferred style.

Note

1. Whether the app is supported on a certain device and what features are available may vary by device model, carrier, and country/region.
2. If you can't find a certain option on your device, it means the feature is not supported.

Enter text

Enter text on your device

To enter text, tap the screen, which will bring up the keypad.

Copy and paste text

Method:

1. Tap and hold the text to be copied.
2. Drag the cursor to select content.
3. Tap **Copy**.
4. Tap and hold at the area for pasting text.
5. Tap **Paste**.

Note

1. Whether the app is supported on a certain device and what features are available may vary by device model, carrier, and country/region.
2. If you can't find a certain option on your device, it means the feature is not supported.

Screenshots and screen recording

How to take a screenshot

To take a screenshot:

Method 1:

Press and hold the Power button and the Volume down button to take a quick screenshot.

Method 2:

Swipe down with three fingers to take a quick screenshot.

To disable this feature, go to **Settings > Shortcuts & accessibility > S-capture**, and disable **Slide down with three fingers to take a screenshot**.

Note

This feature is not supported in Super Battery Saver mode.

Method 3:

1. Swipe down from the top of the screen to open the Control center.

2. Tap  to enter S-capture.

• S-capture

To record the screen:

1. Tap .

2. Tap **Start screen recording**.

To change the screen recording settings, go to **Settings > Shortcuts & accessibility > S-capture**.

3. Tap  to start recording and  to pause recording.

4. Tap  to finish recording.

Note

The recording will be stopped and saved automatically when the duration reaches 59 minutes 59 seconds or when the screen is off for 60 seconds during the recording.

To take a long screenshot:

1. Tap .

2. Drag the upper bezel to determine the start position.

3. Swipe on the screen to determine the screenshot scope.

4. Tap **Save**.

To take a rectangular screenshot:

1. Tap .

2. Drag the marquee to select the area to be captured.

3. Tap .

To record an animation:

1. Tap .

2. Drag the marquee to select the area to be recorded.

3. Tap  to start recording.

4. Tap  to stop recording.

Note

The recording can't be longer than 15 seconds, and it will be automatically saved as a GIF animation.

To take a funny screenshot:

1. Tap .

2. Select a screenshot pattern you prefer.

3. Select the content to be captured.

4. Tap .

Control center features

You can quickly access frequently used shortcuts, view system notifications, and more from the Control center.

Open or close the Control center

Method:

- To open the Control center, swipe down from the top of the screen.
- To close the Control center, swipe up on the screen.

Introduction to the Control center

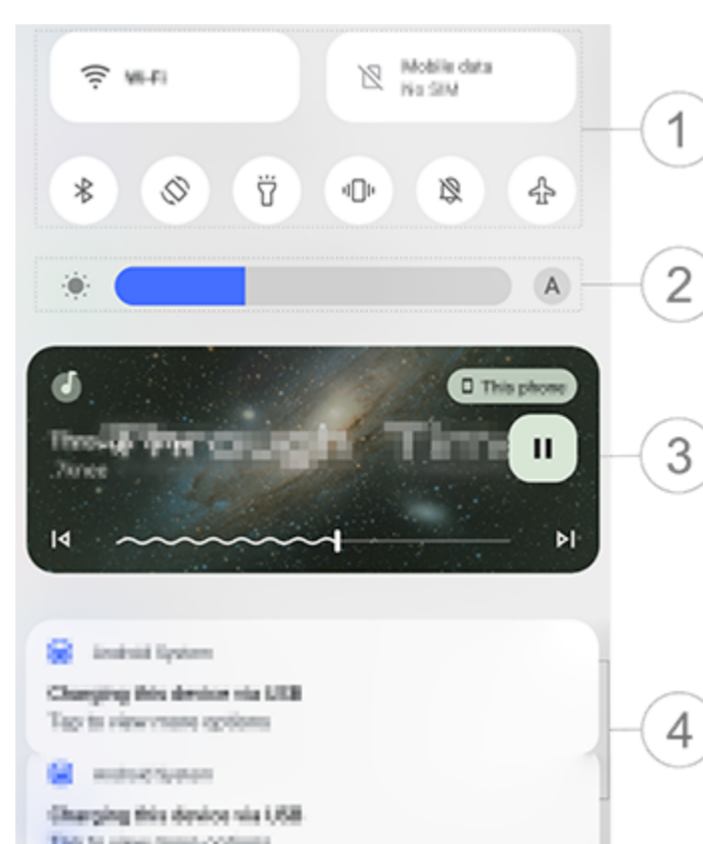

Note

The illustration is for reference only. Some options may not be available on specific models.

- ① Shortcuts panel.
- ② Screen brightness controls.
- ③ Music playback controls (displayed when Music is in use).
- ④ System notification bar.
 - To delete a notification, swipe left on it (available for some notifications).
 - To clear all notifications, tap **Clear all** (available for some notifications).
 - To manage system notifications, tap **Manage**.

Introduction to the shortcuts panel

• Expand the shortcuts panel

Swipe down from the top of the screen to open the Control center and swipe down again to expand the shortcuts panel.

• Options on the shortcuts panel

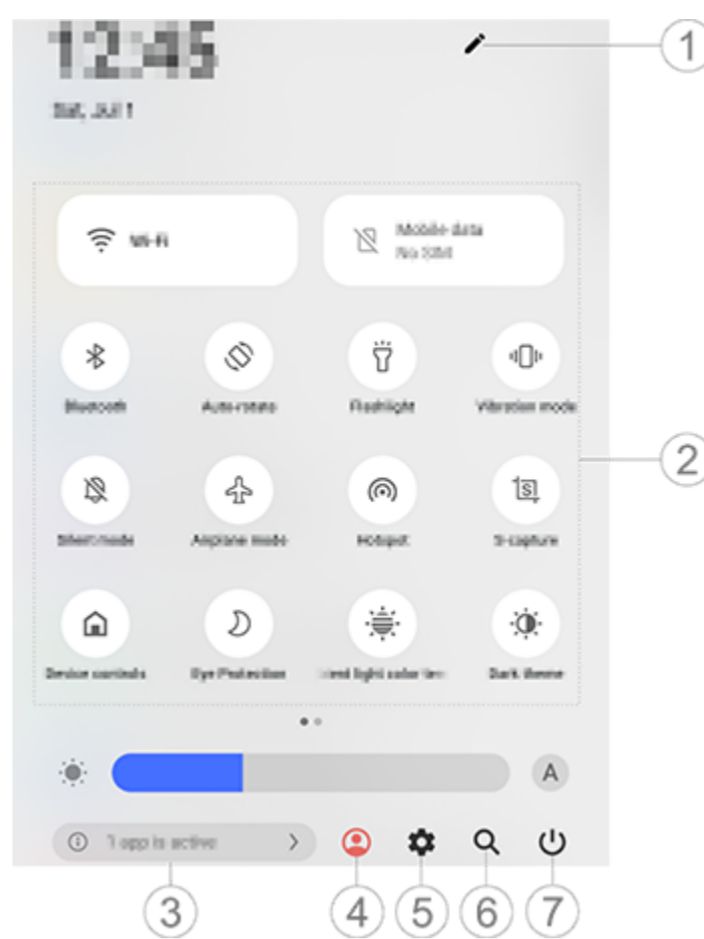

⚠️ Note

The illustration is for reference only. Some options may not be available on specific models.

- ① Add or adjust shortcut options.
- ② Shortcut options.
 - To enable or disable a feature, tap the corresponding option.
 - To access the settings screen of a feature, tap and hold the corresponding option (available for some options).
- ③ View or close running apps.
- ④ Multiple users.
- ⑤ Tap to access **Settings**.
- ⑥ Search for local and web content (available in some countries).
- ⑦ Tap to disable or restart the device.

⚠️ Note

1. Whether the app is supported on a certain device and what features are available may vary by device model, carrier, and country/region.
2. If you can't find a certain option on your device, it means the feature is not supported.

Lock screen features

You can lock or unlock your screen, and configure the lock screen in the following ways.

Lock your screen

To lock your screen:

- Press the Power button to manually lock the screen.
- Go to **Settings > Display & brightness > Screen timeout**, and select a preferred duration. The screen will lock automatically after it has been inactive for the selected duration.

Configure the lock screen

To change the lock screen style and create a lock screen shortcut:

Method:

1. Go to **Settings > Lock screen & wallpaper > Lock screen settings**.
2. Do any of the following:
 - To set the lock screen clock, date style, or features that can be quickly started on the locked screen, go to **Custom lock screen**
 - To change the lock screen wallpaper with the theme, enable **Change lock screen wallpaper based on theme**.

Note

Only static wallpapers can change along with themes.

- To open the Control center from the lock screen, enable **Open Control center from the lock screen**.

Unlock your device

If you haven't set up a password lock, fingerprint lock, or face lock, when the screen is locked and turned on, swipe up to unlock your device.

If you have set up a password lock, fingerprint lock, or face lock, when the screen is locked and turned on, unlock your device in the following ways:

- Swipe up on the screen and enter your lock screen password.
- Touch the fingerprint sensor using a registered fingerprint.
- Align your face with the screen. Your device will unlock once your face is recognized.

Note

To learn about how to set up a password lock, face lock, or fingerprint lock, go to **Settings > Security** in the Manual.

Customize the home screen

Add apps and widgets to the home screen

• Add apps to the home screen

Method:

1. Swipe up on the home screen to access the **Apps** screen.
2. Tap and hold an app, drag it to the desired location on the home screen, and then lift your finger.

• Add widgets to the home screen

Method:

1. Go to the **Widgets** screen in the following ways:
 - Tap and hold a blank area on the home screen, and tap **Widgets**.
 - Swipe up on the home screen, and tap **Widgets**.
2. Tap and hold a widget, drag it to the desired location on the home screen, and then lift your finger.

Customize your home screen

• Create an app folder

Group your apps for better management as follows:

Method:

1. Tap and hold an app.
2. Drag the app to another app and lift your finger to automatically create a folder.
3. To rename the folder, select one of the following methods:
 - Tap and hold the folder, and tap **Rename**.
 - Open the folder and tap the folder name to rename it.

• Remove or uninstall an app

Remove or uninstall an app in the following ways:

- Tap and hold the app, and tap **Remove** or .
- Tap and hold a blank area on the home screen to access editing mode, select the app you want to remove, and then tap **Remove**.

• Remove a widget

Method:

Tap and hold a widget, and then tap **Remove**.

Tap and hold a blank area on the home screen to access editing mode and tap .

• Rearrange the home screen

Method:

1. Tap and hold a blank area on the home screen to access editing mode.
2. Tap and hold a screen and drag it to the desired location, and then lift your finger.

Use Smart split

You can enable split-screen mode to use two apps on the same screen. With split-screen mode enabled, incoming messages from another app appear as floating icons. Tapping the icon splits the screen into two, allowing you to view messages from both apps simultaneously.

Enable split-screen mode

Enable split-screen for apps that support this mode in the following ways:

Method 1:

1. Access the Recent apps screen.
2. Tap  >  **Split-screen**.

Method 2:

If you have enabled the "Slide up with three fingers to split screen" feature, split the screen by sliding up with three fingers.

To enable the "Slide up with three fingers to split screen" feature, go to **Settings > Shortcuts & accessibility > screen-split** and enable **Slide up with three fingers to split screen**.

Method 3:

1. Swipe down from the top of the screen to open the Control center, and swipe down again to expand the shortcuts panel.
2. Tap .

Enable message screen-split

Method:

1. Go to **Settings > Shortcuts & accessibility > Screen split**, and enable **Message screen-split**.
2. Select the apps from which notifications will be displayed as floating messages.

Upgrade your device



Note

Unauthorized ROM flashing or system updates may incur security risks. You are advised to back up your data before upgrading the system.

• **Automatically detect updates**

To detect updates:

- Go to **Settings** > **System update**. Your device will automatically detect available updates. You can download and install them as needed.
- Go to **Settings** > **System update** > , and enable **Smart Upgrade**. This allows your device to automatically download and install updates via Wi-Fi during idle hours at night.

Note

1. You must connect your device to the internet to use this feature.
2. System updates may incur a large amount of data. You are advised to download them over Wi-Fi.
3. If there are no available updates, it indicates that your device is already up to date.

• **Upgrade your device with an existing package**

To upgrade your device with an existing package:

1. Go to **Settings** > **System update** >  > **Local upgrade**. Your device will automatically scan for available packages.
2. Select a package to install and tap **Update now**.

Note

A system update package is required on your device to use this option.

Find devices

To remotely locate, find, lock, or erase your device, make sure your device:

- Is powered on.
- Has **Find My Device** enabled.
- Is signed in to your Google account.
- Is connected to a network.
- Has Location enabled.
- Is visible on Google Play.

Remotely find and erase your device

Method:

1. Go to **Settings** > **Security** > **Find My Device**, tap the '**Find My Device**' website or go to Google to find the website of the device, and sign in to the Google account.
2. The lost device receives a notice.
3. Obtain the approximate or last position of the lost device.
4. Select an operation to perform.

Note

1. To learn more about other options, go to **Settings** > **Security** > **Find My Device** > **Learn more**.
2. You must connect your device to the internet to use this feature.

Use accessibility shortcuts

You can quickly enable an accessibility feature with a floating button from Accessibility.

Method:

1. Go to **Settings > Shortcuts & accessibility > Accessibility** to enable accessibility features, such as TalkBack.
2. Tap the floating button to use the accessibility features.
3. To change the position, size, and transparency of the floating button, go to **Accessibility > Accessibility shortcuts > Accessibility button**.

Note

This is an overview of Accessibility features. For more information, go to **Settings > Shortcuts & accessibility** in the Manual.



Home Screen Apps

iManager

Tap  to access the iManager app to free up space, view data usage, scan for vulnerabilities, and more.

Manage your device

Do any of the following:

- To detect and optimize your device's health, tap **Optimize**.
- To scan for and clean up cached junk files, go to **Space cleanup > Clean up all**.
- To view the monthly or daily mobile data/Wi-Fi data usage, go to **Data management > Data usage/Wi-Fi data usage**.
- To manage the use of the mobile network or Wi-Fi on a per-app basis, go to **Data management > Network management > Mobile network or Wi-Fi**, and then tap  next to any app to enable or  to disable their access to the respective network.
- To identify potential risks and malicious apps on your device, tap **Security scan**.

Note

There may be a discrepancy between the data consumption displayed on your device and the data usage reported by your carrier.

Other security & privacy and system management tools

To use app encryption, phone cooling, and other tools, go to  **Utility tools** and tap the features as needed.



Camera

⚠️ Tip: Whether the app is supported on a certain device and what features are available may vary by device model, carrier, and country/region. Please contact your distributor or service provider for more information.

Take photos or record videos to capture wonderful moments in your life anywhere, anytime with Camera on your phone.

Open Camera



To open Camera:

- From the home screen, tap .
 - When the screen is locked, turn on the screen, and then swipe up on the  icon.
 - If Quick action for Camera is enabled, double-tap the Volume down button when the screen is off.
- To enable Quick action for Camera: Go to **Settings > Shortcuts & accessibility > Quick action** and select **Quick action for Camera**.

Customize the layout of camera modes

You can customize the layout of camera modes available on your device.

Method:

1. On the main camera screen, tap **More** > .
2. Customize the layout of cameras as follows:
 - Tap .
 - Drag a mode to the desired location.
3. Tap **Done**.

⚠️ Note

Photo and Video modes can't be repositioned, subject to specific models.

Photo mode



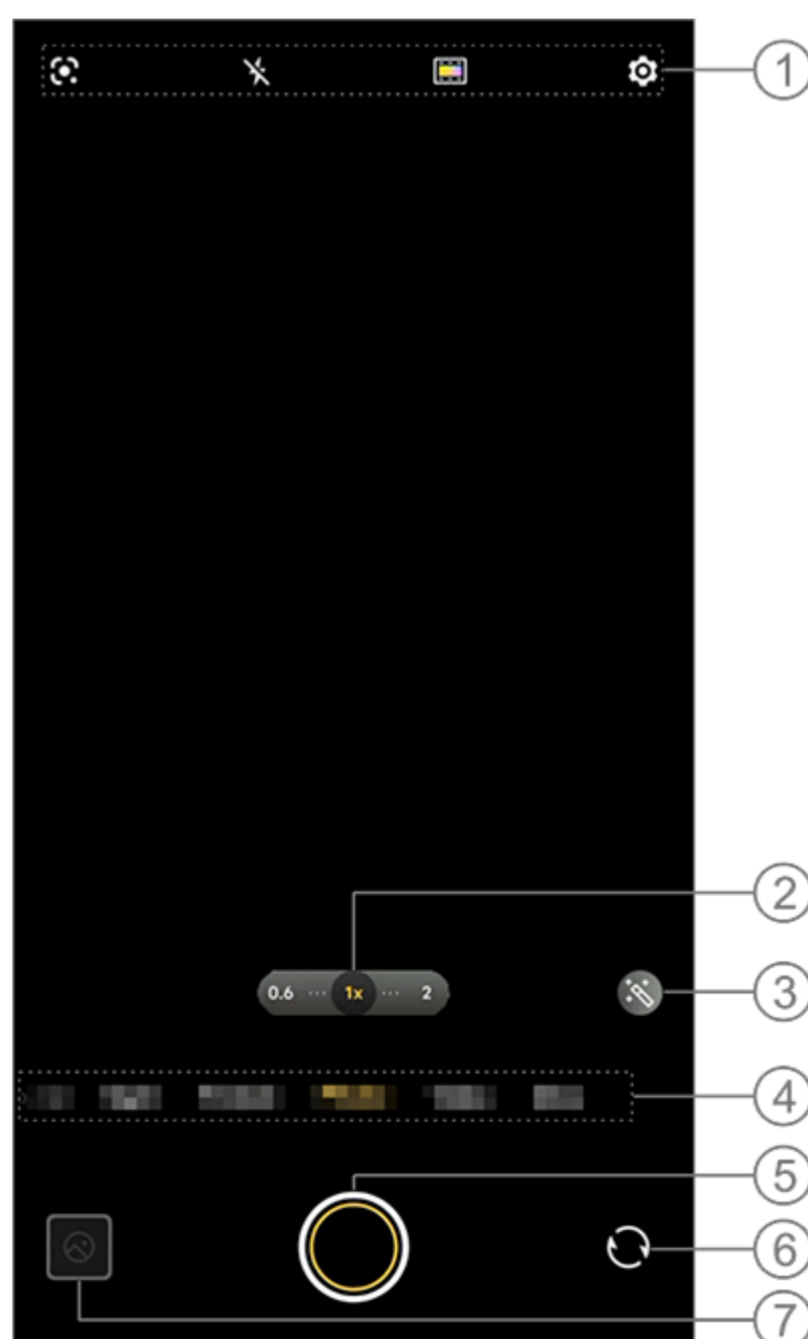



Take photos of plants or landscape in **Photo** mode.



⚠️ Note

The illustration is for reference only. Some options may not be available on specific models.



① To enable or disable a feature, tap the corresponding icon. The icons are described as follows:

	Flash off
	Flash on
	Flash always on
	Flash auto on
	Image recognition, used to search for items in the image
	Adjust the screen color and style

- ② Drag to zoom in or out the screen.
- ③ Apply filter effects.
- ④ Swipe left or right to switch between modes.
- ⑤ Tap to take a photo.
- ⑥ Switch between the front and rear cameras.
- ⑦ Preview the captured images.

• To take photos:

You can take photos by using the following method:

- On the main camera screen, tap .
- On the main camera screen, press either volume button.
- To take burst photos, tap and hold .

Note

Burst photos are not supported when a filter is applied in Photo mode.

• Image recognition

Search for a specific image or item, or translate text into a different language.

Method:

1. Tap  in Photo mode.
2. Swipe left and right on the screen to select an option.
3. Frame the target object within the viewfinder and press the button.



Note

You must connect your device to the internet to use this feature.

• Filters

Apply various artistic effects to your photos.

Method:

1. Tap  in Photo mode.
2. Select Filters.
3. Tap .

Video mode

Record or shoot a video in **Video** mode.

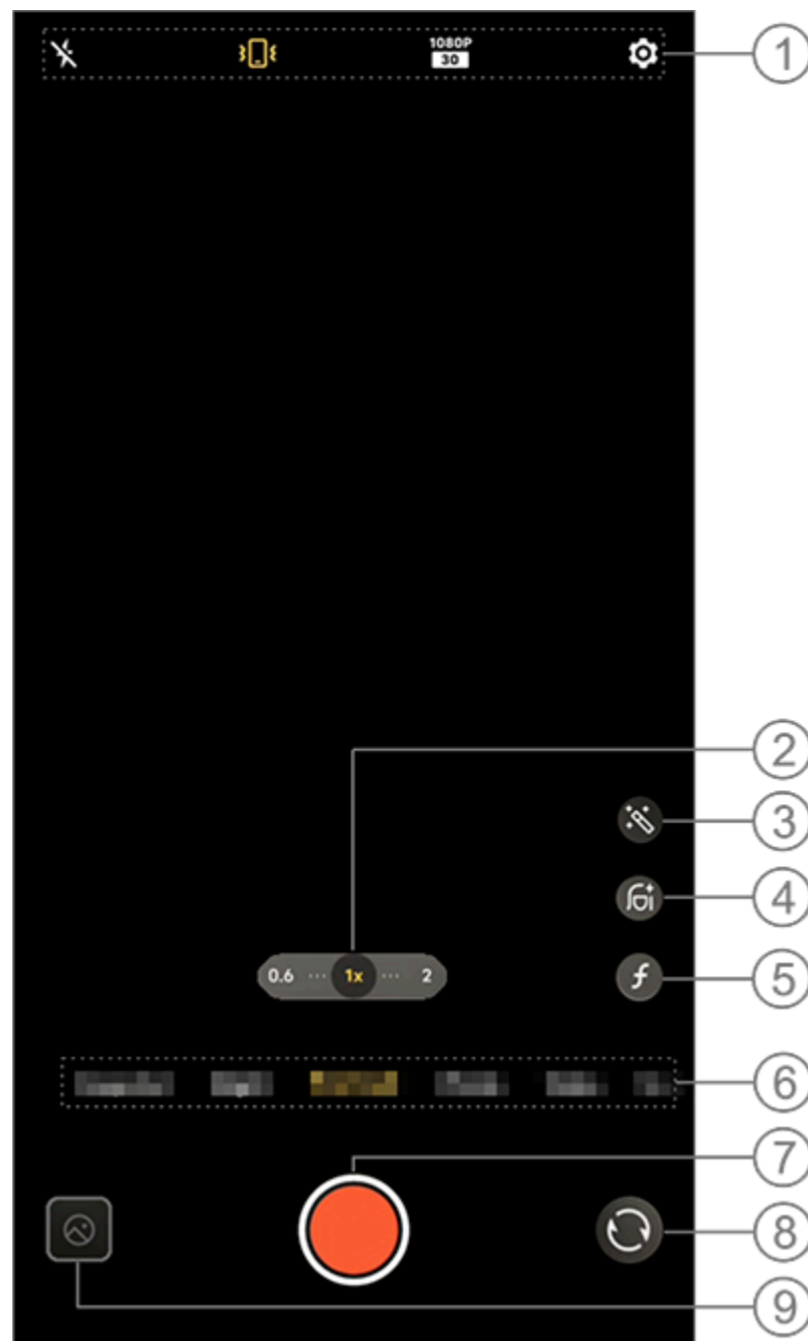

Note

The illustration is for reference only. Some options may not be available on specific models.

① To enable or disable a feature, tap the corresponding icon. The icons are described as follows:

	Flash off
	Flash always on
	Standard stabilization on
	Stabilization off
	1080p picture quality
	4K picture quality
	Vocal enhancement on
	Vocal enhancement off

- ② Drag to zoom in or out the screen.
- ③ Apply filter effects.
- ④ Select beauty effects for videos.
- ⑤ Adjust video bokeh effects.
- ⑥ Swipe left or right to switch between modes.
- ⑦ Tap to start recording.
- ⑧ Switch between the front and rear cameras.
- ⑨ Preview the recorded videos.

• Record a video

Method:

1. Tap **Video**.

2. Tap .

• Adjust the video resolution

Use this option to adjust the video resolution.

The higher the resolution is, the clearer the video will be, resulting in a larger video file.

Method:

1. Go to **Video**.

2. Select , , or .

3. Tap .

• Video stabilization

Activate anti-shake to keep the focus steady when the camera is moving.

Method:

1. Go to **Video**.

2. Select .

3. Tap .

4. You may tap  to disable video stabilization.

• Beauty effects

Apply smoothing, whitening, or other effects to your videos.

Method:

1. Go to **Video**.

2. Tap .

3. Select a beauty option.

4. Tap .

• Overview of features during video recording

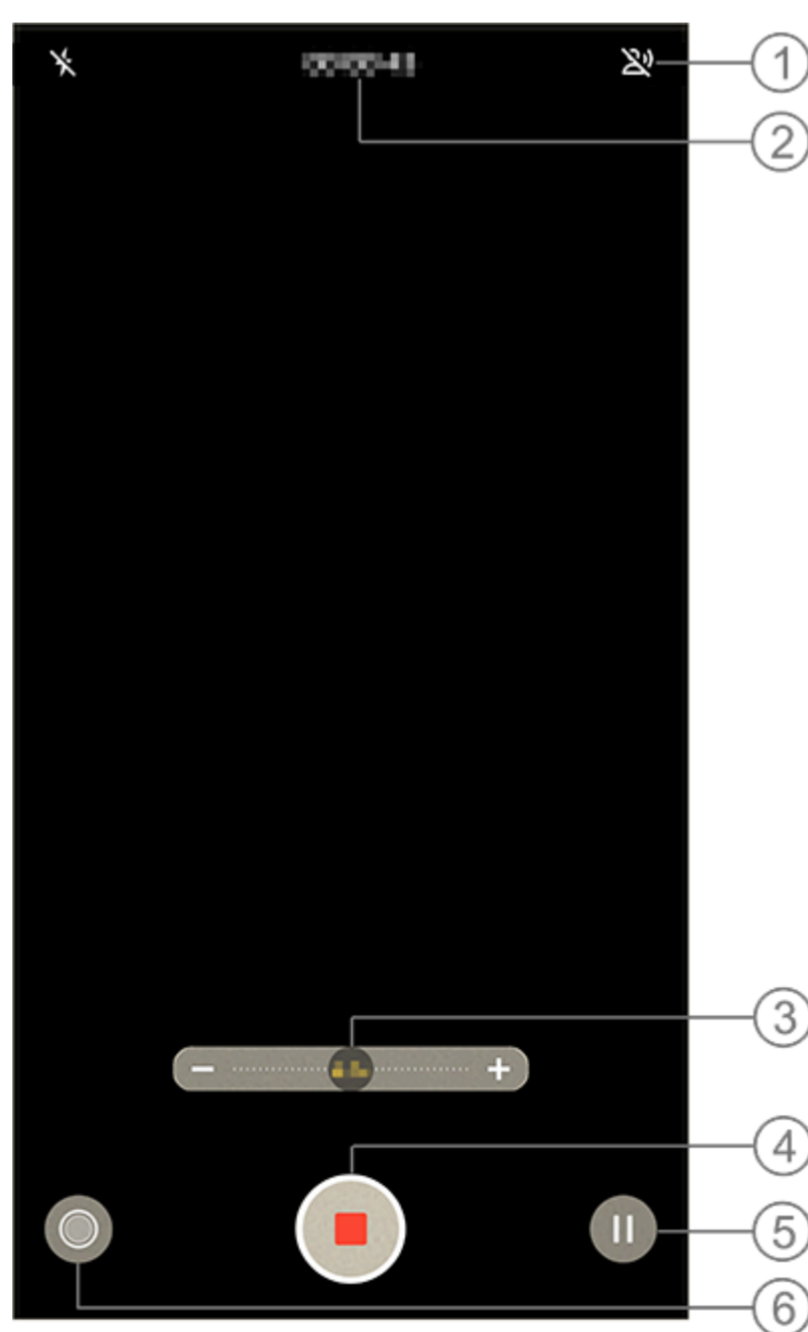

- ① Highlight human voice by automatically lowering the ambient noise level during recording.
- ② View the current length of the video.
- ③ Drag to zoom in or out the screen.
- ④ Save the recorded video.
- ⑤ Pause recording.
- ⑥ Snap a still photo while recording.

50 MP photos

Access **50 MP** mode if you would like to develop or print photos, or display them on a large screen.

Method:

1. Go to **50 MP**.
2. Tap .

Night mode

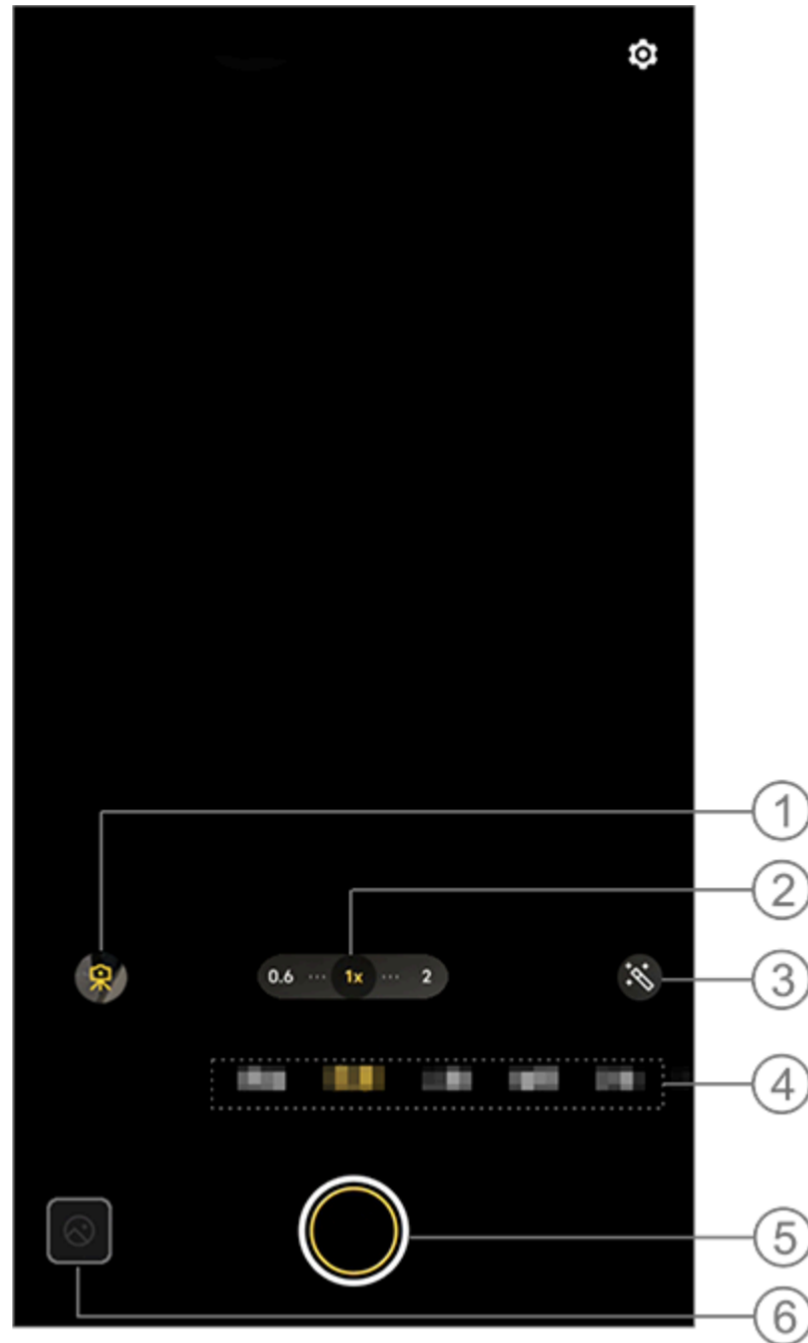

Night mode gives your photos brighter colors and sharper details during shooting in low-light or dimly-lit environment.



Note

The illustration is for reference only. Some options may not be available on specific models.

① To enable or disable a feature, tap the corresponding icon. The icons are described as follows:

	Tripod detection on
	Tripod detection off

- ② Drag to zoom in or out the screen.
- ③ Switch between photo effects.
- ④ Swipe left or right to switch between modes.
- ⑤ Tap to take a photo.
- ⑥ View the taken photos.

• To take photos:

Method:



1. Go to **Night mode**.
2. Tap .

Portrait mode

Portrait mode lets you apply Bokeh, beauty, and other effects to your photos to shoot stunning portraits.

• Bokeh effects

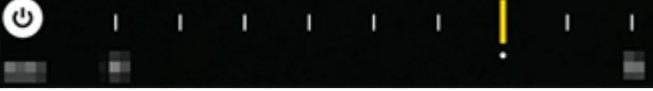

To save photos as Bokeh files:

1. Go to **Portrait**.
2. Tap .
3. Swipe  left and right to adjust the Bokeh degree.
4. Tap .
5. You may tap **Off** to disable Bokeh.

• Beauty/Posture guidance

Enhance facial features or get on-screen guidance on shooting postures.

To apply beauty effects or get posture guidance:

1. Go to **Portrait**.
2. Tap .
3. Select **Beauty/Posture**.
4. Tap .
5. You may tap  to disable HD portrait mode.

Note





You must connect your device to the internet to use this feature.

Pro mode

Pro mode gives you full control when taking photos or recording videos.

• Description of features or icons

You can manually adjust parameters of each feature to produce the best effects.

-  EV: Adjust the standard exposure set in Camera. Increase the EV to produce brighter pictures, and decrease the EV to produce darker pictures.
-  ISO: The sensitivity of image sensors to light.
-  S: The length of time in which light is exposed to image sensors.
-  WB: Achieve accurate colors in your photos.



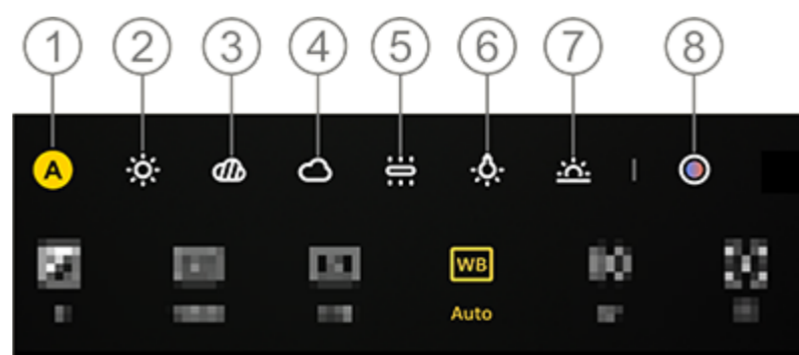



The scenes for WB are specified in the illustration below. You can enable or disable the feature as needed.



Note

The illustration is for reference only. Some options may not be available on specific models.

- ① WB (Auto).
- ② WB (Sunny).
- ③ WB (Overcast).
- ④ WB (Cloudy).
- ⑤ WB (Incandescent).
- ⑥ WB (Tungsten light).
- ⑦ WB (Sunset).
- ⑧ WB color temperature/tone: Drag the slider to adjust the value.

- : AF for Autofocus/MF for Manual Focus.
-  : Matrix metering/ Center-weighted metering/ Spot metering
- : Tap to learn more about each feature.
- : Tap to reset parameters to default.

Note

Some options may not be supported or may vary by device model.

• Change the storage format of photos

This feature allows you to save the photos taken in Pro mode as uncompressed RAW/JPG files.

To save photos as RAW files:

1. Go to **Pro**.
2. Tap .
3. Tap .

Note

1. The photos taken with this feature enabled will be saved in both RAW and JPG formats.
2. RAW photos retain more details for post-processing, resulting in larger file sizes, whereas photos in JPG format take up less storage space.

Take panoramic photos

Pano mode combines multiple shots into a seamless panoramic photo.

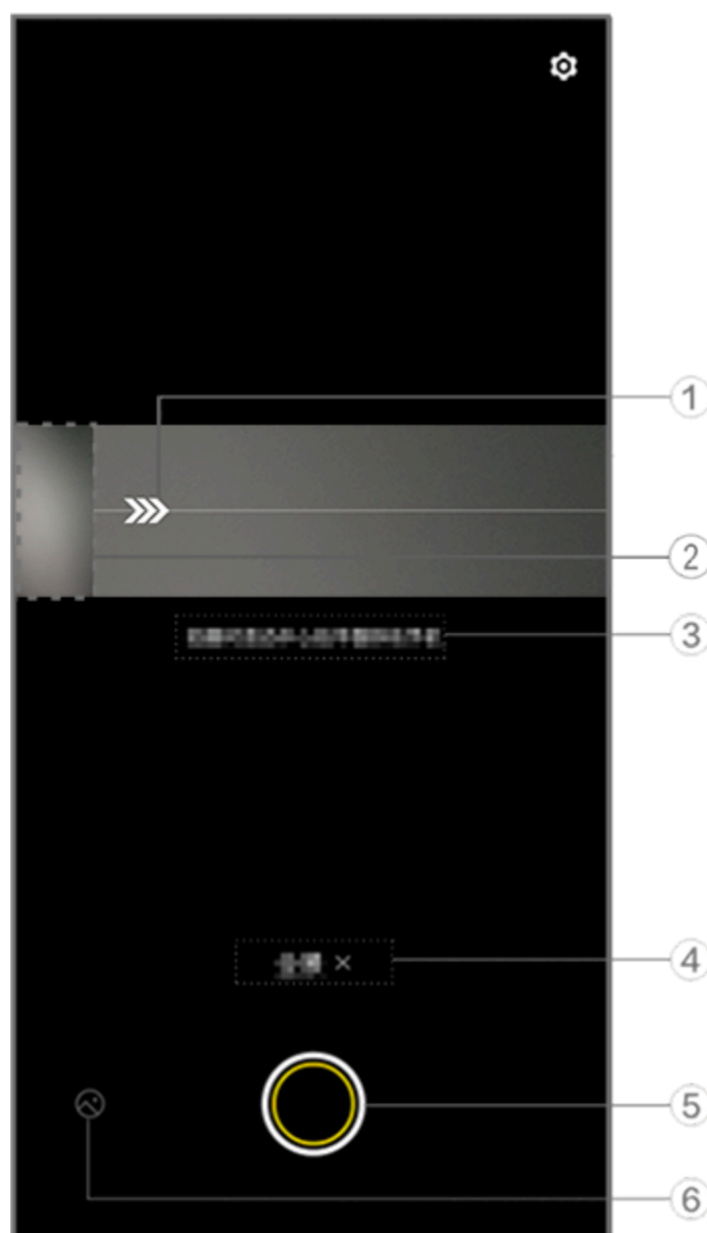

Note

The illustration is for reference only. Some options may not be available on specific models.

- ① Move the camera in the direction of the arrow.
- ② Frame viewer.
- ③ Prompts.
- ④ Tap to disable the current mode.
- ⑤ Tap to take a photo.
- ⑥ View the taken photos.

• To take photos:

Method:

1. Tap .
2. Move the device steadily as prompted.
3. If you do not move the device for a specified long time, the device automatically stops photographing and saves the taken photos.

Take live photos



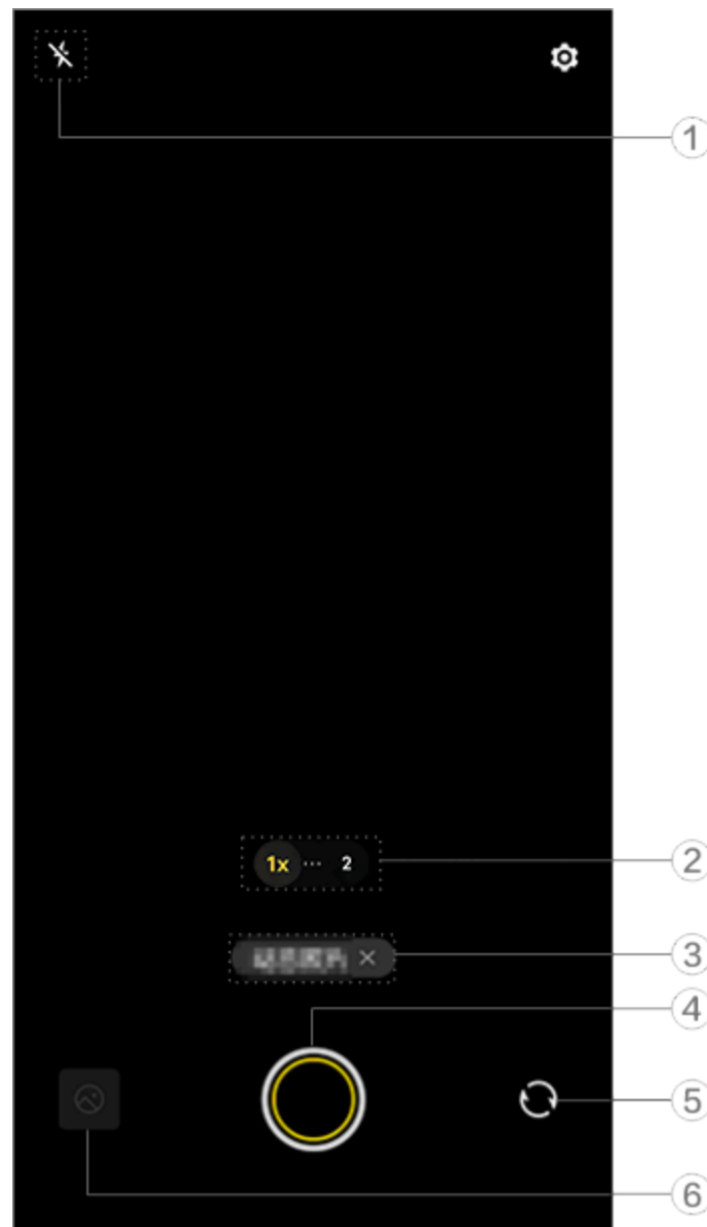

Live Photo mode allows you to shoot a live photo that is about 3 seconds long.



Note

The illustration is for reference only. Some options may not be available on specific models.

① Flash settings.

	Flash off
	Flash on
	Flash always on
	Flash auto on

- ② Drag to zoom in or out the screen.
- ③ Tap to disable the current mode.
- ④ Tap to take a photo.
- ⑤ Switch between the front and rear cameras.
- ⑥ View the taken photos.

• To take live photos:

Tap . The photos captured within a 3-second timeframe before and after tapping the shutter button will be automatically saved.

Note

Burst photos are not supported in Live Photo mode. The shutter doesn't make a sound when Live Photo is enabled.

Record slo-mo videos

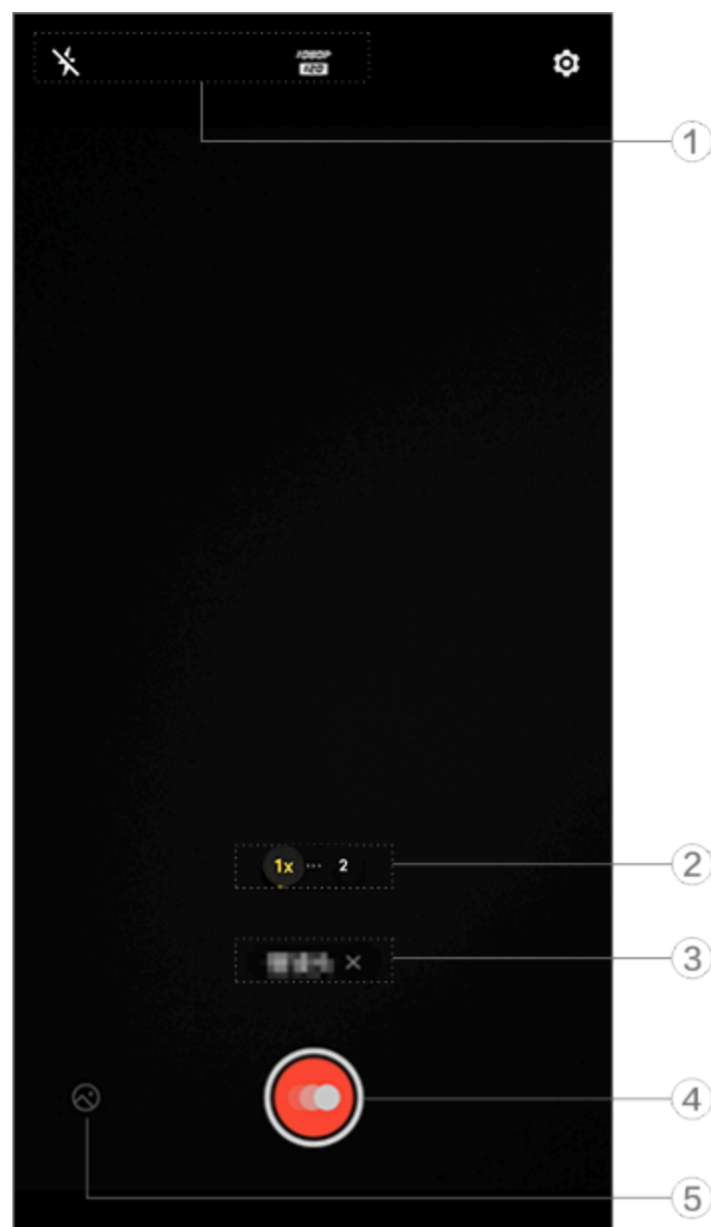

Slo-mo mode allows you to record a video at a higher frame rate while playing it at a lower frame rate.



Note

The illustration is for reference only. Some options may not be available on specific models.



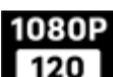

① Flash and picture quality settings.

	Flash off
	Flash always on
	720p picture quality
	1080p picture quality

- ② Drag to zoom in or out the screen.
- ③ Tap to disable the current mode.
- ④ Tap to start recording.
- ⑤ Preview the recorded videos.

•To record videos:

Method:

1. Tap  to start recording.
2. Tap  to pause recording, and tap  to continue recording.
3. Tap  to finish recording.

Record time-lapse videos



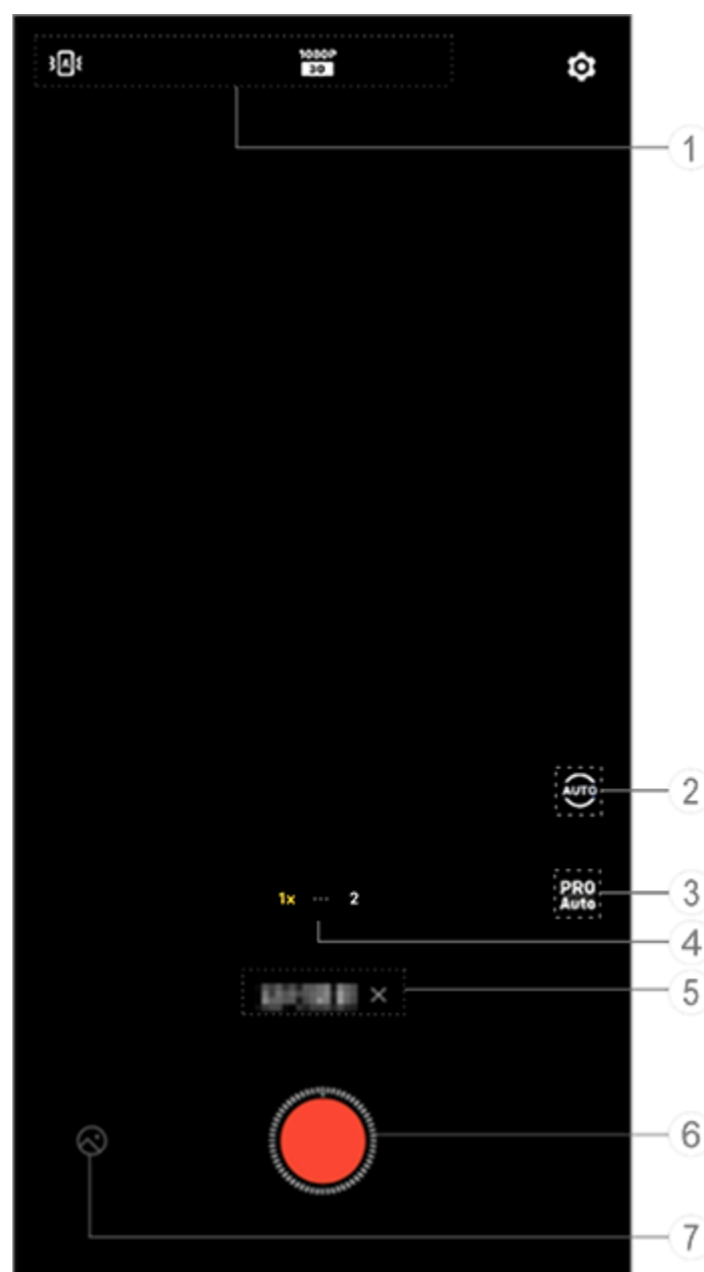

You can use **Time-lapse** mode to create a time-lapse video of an experience over a period of time.



Note

The illustration is for reference only. Some options may not be available on specific models.

① Set Standard stabilization and screen quality.

	Standard stabilization auto adjustment on
	Standard stabilization off
	720p picture quality
	1080p picture quality
	4K picture quality

② Select shooting interval and shooting duration.

③ Adjust values of function parameters such as sensitivity and WB.

④ Drag to zoom in or out the screen.

⑤ Tap to disable the current mode.

⑥ Tap to start recording.

⑦ Preview the recorded videos.

•To record videos:

Method:

1. Tap  to start recording.

2. Tap  to finish recording.

Take photos of the moon

Supermoon mode allows you to take splendid photos of the moon.

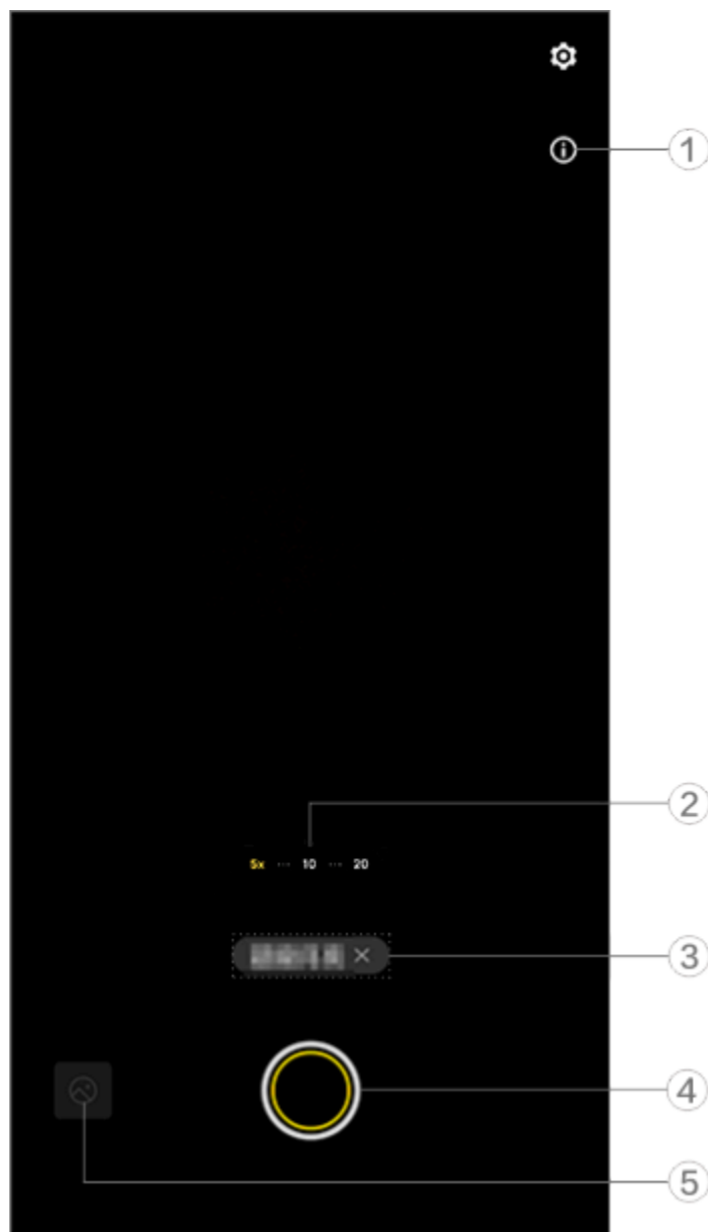

Note

The illustration is for reference only. Some options may not be available on specific models.

- ① Tap to view the tutorial.
- ② Drag to zoom in or out the screen.
- ③ Tap to disable the current mode.
- ④ Tap to take a photo.
- ⑤: View the taken photos.

• **To take photos:**

Adjust the zoom to 10x or more, tap , and hold your device steady until shooting is complete. Note that the mode may not work when the moon is blocked.

Note

For better shooting effects, keep the lens clean.

Capture snapshots

Snapshot mode allows you to capture fast-moving actions with ease.

Method:

1. Go to **Snapshot**.
2. Tap .

Note

This mode is available only when the rear camera is used.

Dual View mode

Dual View mode splits the recording screen into two views (front and rear camera views), allowing you to watch them side by side.

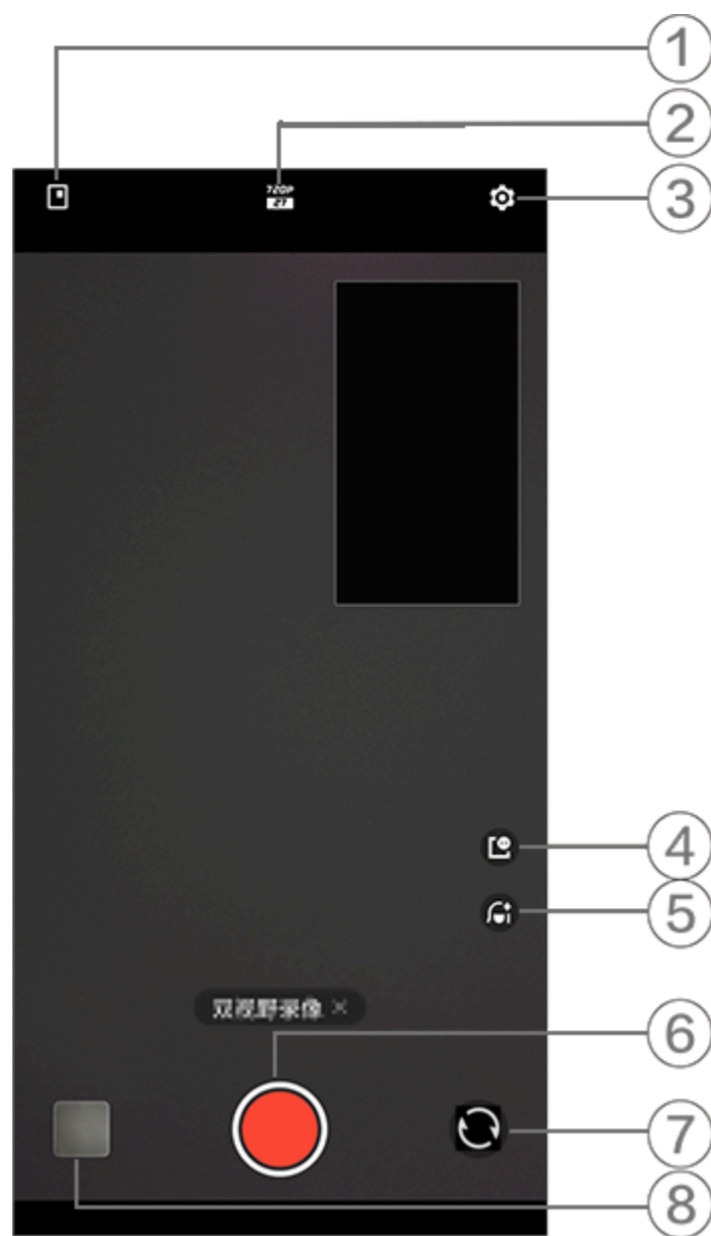

Note

The illustration is for reference only. Some options may not be available on specific models.

- ① Tap to switch floating window sizes.
- ② Switch between a variety of camera resolutions.
- ③ More settings.
- ④ Tap to adjust floating window styles.
- ⑤ Swipe left or right to switch between beauty effects (available only when the front camera is used).
- ⑥ Tap to record a video.
- ⑦ Switch between the front and rear cameras.
- ⑧ Preview the taken images or videos.

Method:

1. Go to **Dual View**.
2. Tap .

Additional features in Camera modes

Tap to adjust or enable more features in each Camera mode.

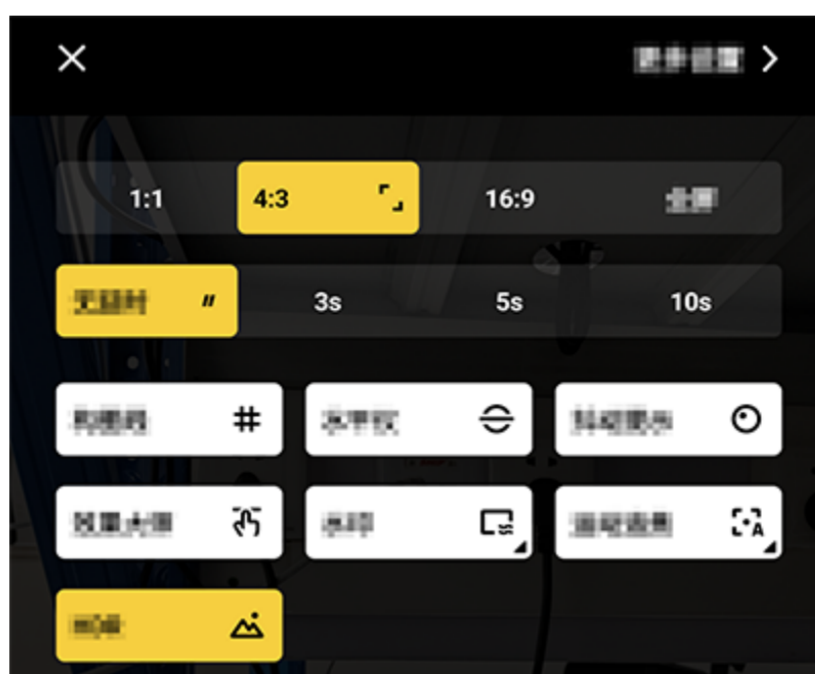













Note

The illustration is for reference only. Some options may not be available on specific models.

To enable or disable a feature, tap the corresponding icon. The icons are described as follows:

	Select an aspect ratio
	Select the self-timer
	Grid line on

#	Grid line off
	Level on
	Level off
	Effects Master on
	Effects Master off
	Watermark on
	Watermark off
	Motion Autofocus on
	Motion Autofocus off
	Jitter prompt on
	Jitter prompt off
	HDR on
	HDR off
	More settings

Note

1. Some options may not be available or may vary depending on your country/region and device model.
2. If you can't find a certain option on your device, it means the feature is not supported.

Configure more settings

To configure more settings, tap  > **More settings** in the upper-right corner of Camera.

Do any of the following:

- To play a shutter sound when taking a photo or recording a video, enable **Shutter sound**.
- To attach a location tag to your photos and videos, enable **Location**.
- To capture a shot with the front camera as you see it in the camera frame, enable **Mirrored selfie**.
- To keep the settings used last time, tap **Keep settings** to toggle on the options as needed.
- To add the date & time, device model name, or other content, tap **Watermark** to toggle on the options as needed.
- To calibrate by simulating camera rotation, go to **Micro gimbal calibration**.
- To track and focus on subjects in real time when taking a photo, enable **Motion Autofocus**.
- To take a photo by tapping the screen or using voice commands, go to **Shutter mode** to toggle on the options as needed.
- To remove moles after the beauty feature is enabled, enable **Remove moles** in Portrait function.

Note

The mole removal feature is supported in beauty mode.

- To get assistance in taking portraits, enable **Portrait framing** in Portrait function.

Note

Portrait framing applies only to the rear camera in Photo and Portrait modes.

· To restore Camera settings to default, tap **Reset**.

Note

1. Some options may not be available or may vary depending on your country/region and device model.
2. If you can't find a certain option on your device, it means the feature is not supported.

Albums

To view, edit, share, or organize photos or videos, tap  to access Albums.

Note

You must connect your device to the internet to use some features.

View photos and videos

• **View by shooting time**

Method:

1. Go to  > **Photos**.
2. Pinch in on the screen to switch to the monthly view and pinch out to switch to the daily view.

• **View by album**

Method:

1. Go to  > **Albums**.
2. Some photos and videos are stored in default albums. For example, photos taken with Camera are saved in the Camera album, videos recorded with Camera are saved in the Videos album, and screenshots are saved in the Screenshots album.

• **View by intelligent classification**

Method:

1. Go to  > **Albums**.
2. Tap **More** in Intelligent classification.
3. View photos and videos by their intelligent classification, such as selfie, food, and landscape.

To view by intelligent classification, enable **Intelligent classification** first.

To enable intelligent classification, tap  and enable **Intelligent classification**.

• **Search for photos and videos**

To quickly locate a photo or video by searching with keywords:

Method:



1. Go to  > **Search**.
2. Enter keywords in the search bar, such as landscape and food.

Organize photos and videos

Organize a large number of photos and videos into albums to easily sift through them.



• Create an album

Method:

1. Go to  > **Albums**.
2. Tap **+** > **New album**.
3. Enter a new name.
4. Select photos or videos, and tap .
5. Move or copy the selected files to the new album.



• Move or copy photos and videos

Method:

1. Select the photos and videos you want to move or copy. To select photos or videos:
 - Open the photos or videos in full screen, and tap .
 - From **Photos** or a certain album under **Albums**, tap  or tap and hold to select the photos or videos, and then tap .
2. Select **Copy to Albums** or **Move to Albums**.



• Delete photos and videos

To delete photos or videos:

- Open the photos or videos in full screen, and tap .
- From **Photos** or a certain album under **Albums**, tap  or tap and hold to select the photos or videos, and then tap .



• Restore deleted photos and videos

Method:

1. Go to  > **Albums**.
2. Tap **Recently deleted**.
3. To restore deleted photos and videos:
 - Tap and hold to select the photos or videos you want to restore, and then tap .
 - Open the photos or videos you want to restore in full screen, and tap .

• Hide photos and videos

To hide photos and videos:

- Open the photos or videos in full screen, and tap  > **Hide**.
- From **Photos** or a certain album under **Albums**, tap  or tap and hold to select the photos or videos, and then tap  > **Hide**.

To view hidden photos or videos, tap  > **Hidden photos**.

• Rename photos and videos

To rename a photo or video, open it in full screen and tap  > **Rename**.



• Add photos and videos to Favorites

Method:

1. Open the photos or videos in full screen.
2. Tap .

• Share photos and videos

To share photos and videos:

- Open the photos or videos in full screen, and tap .
- From **Photos** or a certain album under **Albums**, tap  or tap and hold to select the photos or videos, and then tap .













Edit photos

To edit or fine-tune a photo:

1. Open the photo in full screen.

2. Tap .

3. To make a certain edit, tap the corresponding icon. See the table below for the description of each icon.

	Crop and rotate the photo
	Adjust the brightness, contrast, and more of the photo
	Draw or mark on the photo
	Apply beauty effects
	Apply filter effects
	Add text
	Add mosaic
	Add stickers
	Add borders
	Remove objects
	Enhance the lighting effect
	Focus on the subject and blur the rest

Edit videos

To edit a video, open it in full screen and tap .

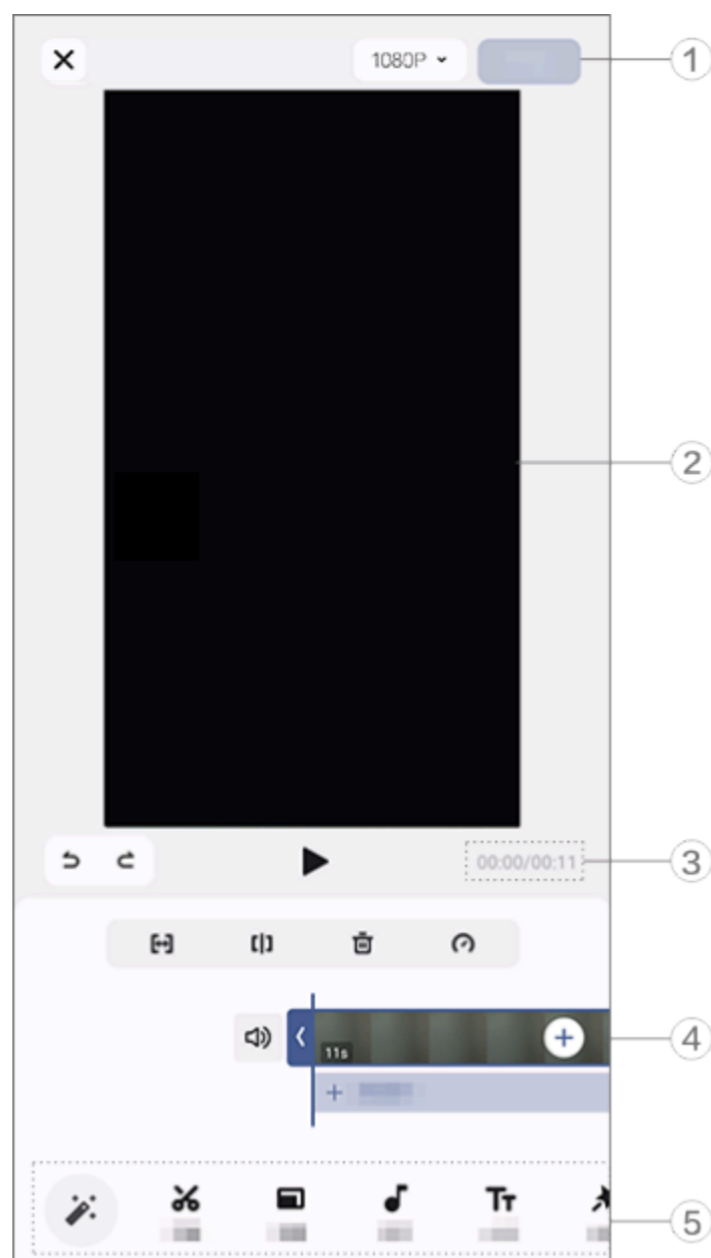













Note



The illustration is for reference only. Some options may not be available on specific models.

- ① Export and save the edited video.
- ② Frame viewer.
- ③ View the progress.
- ④ View the video clip.
- ⑤ Tap the following icons as needed.

See the table below for the description of each icon.

	Go back/discard edits made to the video
	Undo edits
	Redo edits
	Play and preview the current video clip
	Trim the video
	Split the video at the current position
	Delete the video clip
	Adjust the speed of the video
	Sound on
	Sound off
	Add photos/videos
	Add music

• Edit videos



- To edit a video with the AI editing feature, tap .
- To edit a video manually, tap  to manually trim, split, or delete video clips.

• Adjust the aspect ratio or background color

To adjust the aspect ratio, rotate or flip an image, or add a background color, tap .





• Add background music

Method:

1. Tap  **Add music** or  to select music materials.
2. Drag and select a music clip and adjust the music volume.
3. Tap .

• Add text

Method:



1. Tap .
2. Drag the video clip to a required position.
3. Tap , enter text, select font color and pattern, and tap .
4. Drag the two ends of the video clip to modify the start time when the text is displayed.
5. Tap .

• Add a theme

To add a theme, tap  to select a theme style you like.

• Apply filter effects

Method:

1. Tap .
2. Select your preferred filter and adjust its parameters.
3. Tap .

Recommended

Albums automatically creates **Recommended** albums based on the people, places, and group photos important to you.

Note



The Recommended tab won't appear until enough photos are added to Albums.

Calculator

Tap  on the home screen to access the Calculator app to perform basic arithmetic calculations, convert currencies, and more.

Open Calculator

To open Calculator:

- Swipe up from the bottom of the home screen and tap  from all apps.
- Swipe down from the top of the screen to open the Control center, swipe again to expand the shortcuts panel, and then tap .

Switch between Calculator modes

To switch between Calculator modes, tap the following icons as needed:

: Standard calculator for basic arithmetic calculations.

: Scientific calculator involving advanced operators and functions.

: Forex rate calculator for currency conversion.

: View the calculation history for the Standard or Scientific calculator.

Note

You must connect your device to the internet to use the Forex rate calculator.

Recorder

With the Recorder app, you can use your phone as a portable recording device to record personal notes, work-related ideas, and more. To access Recorder, tap  on the home screen.

Create a recording file

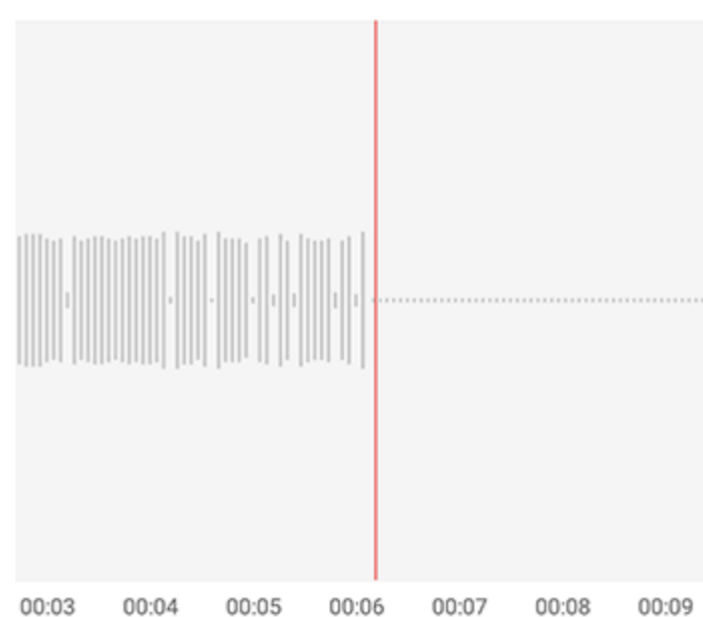





00:00:06



Note

The illustration is for reference only. Some options may not be available on specific models.

During recording, tap the following icons as needed:

	Start recording
	Pause recording
	Stop and save recording
	Mark a time point



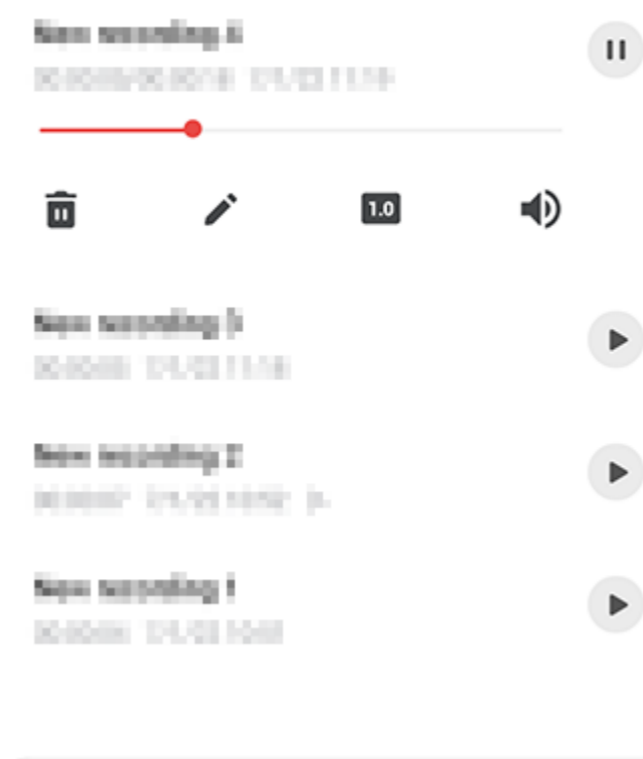



Play a recording file



Note



The illustration is for reference only. Some options may not be available on specific models.

While playing a recording, tap the following icons as needed:

- : Play recording.
- : Pause playback.
- : Switch between playback speeds.
- : Switch between speaker and handset modes.
- : Delete recording.
- : Drag to jump to a specific point in the recording.



Delete a recording file

To delete a recording file:

- Tap and hold a file to select it, and then tap .
- On the playback screen, tap  > **Delete**.



Rename a recording file

To rename a recording file:

- Tap and hold a file to select it, and then tap .
- On the playback screen, tap  > **Rename**.

Share a recording file

To share a recording file:

- Tap and hold a file to select it, and then tap .
- On the playback screen, tap  > **Share**.



Set a recording file as a ringtone

To set a recording file as a ringtone:

- Tap and hold a file to select it, and then tap  > **Set as ringtone**.
- On the playback screen, tap  > **Set as ringtone**.

Edit a recording file

To edit a recording file:



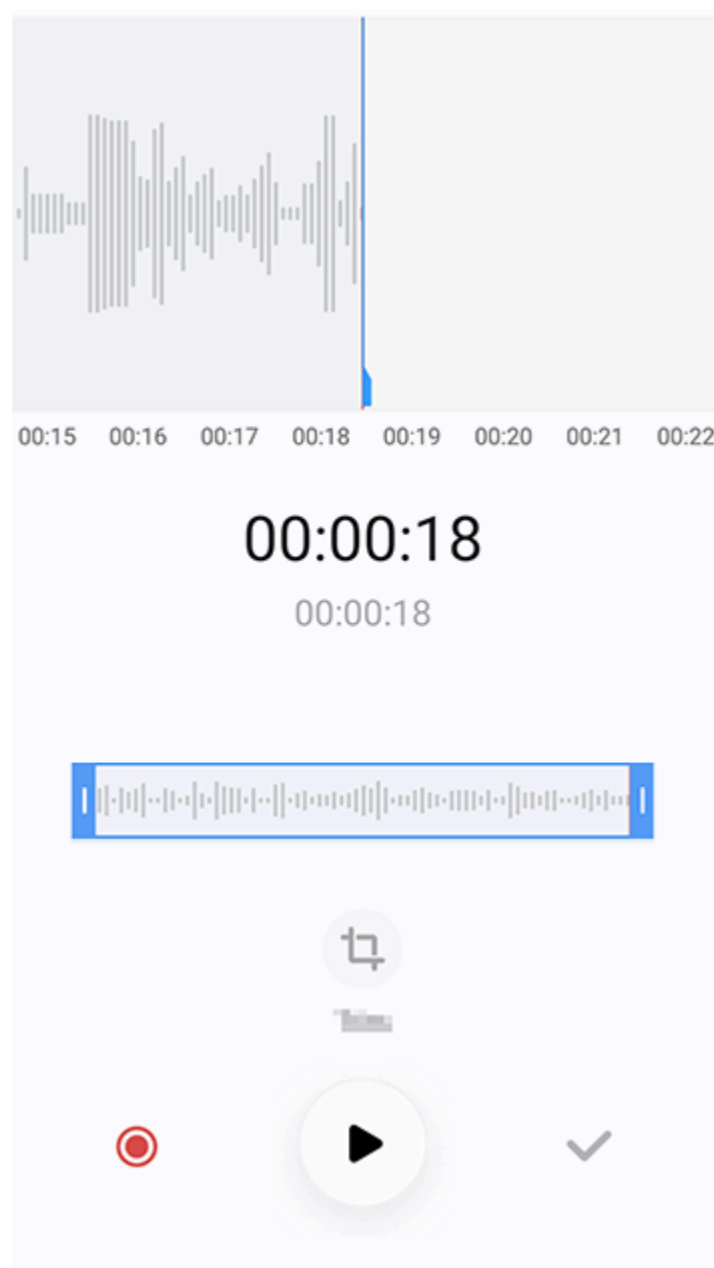

- Tap and hold a file to select it, and then tap .
- On the playback screen, tap  > **Edit**.



Note

The illustration is for reference only. Some options may not be available on specific models.

Method:

1. Drag the trim handles  to select a section of the recording.
2. Tap  to play your selection or  to resume recording.
3. Tap  to keep or delete the selection.
4. Tap .

Reorder recording files

To reorder the files in the list of recordings:

1. In the list of recordings, tap  > **Reorder**.
2. Select a preferred sorting method.

Search for a recording file

To quickly locate a recording file:

1. In the list of recordings, tap .
2. Enter keywords in the search bar.

Clock

To keep track of times around the world, set alarms, and more, tap  on the home screen.

Set an alarm

From the **Alarm** tab, set an alarm to be reminded of an event at a specified time.

• Add an alarm

Method:

1. Tap  from the Alarm tab.

2. Set a time, sound, and more for the alarm.

3. Tap ✓.

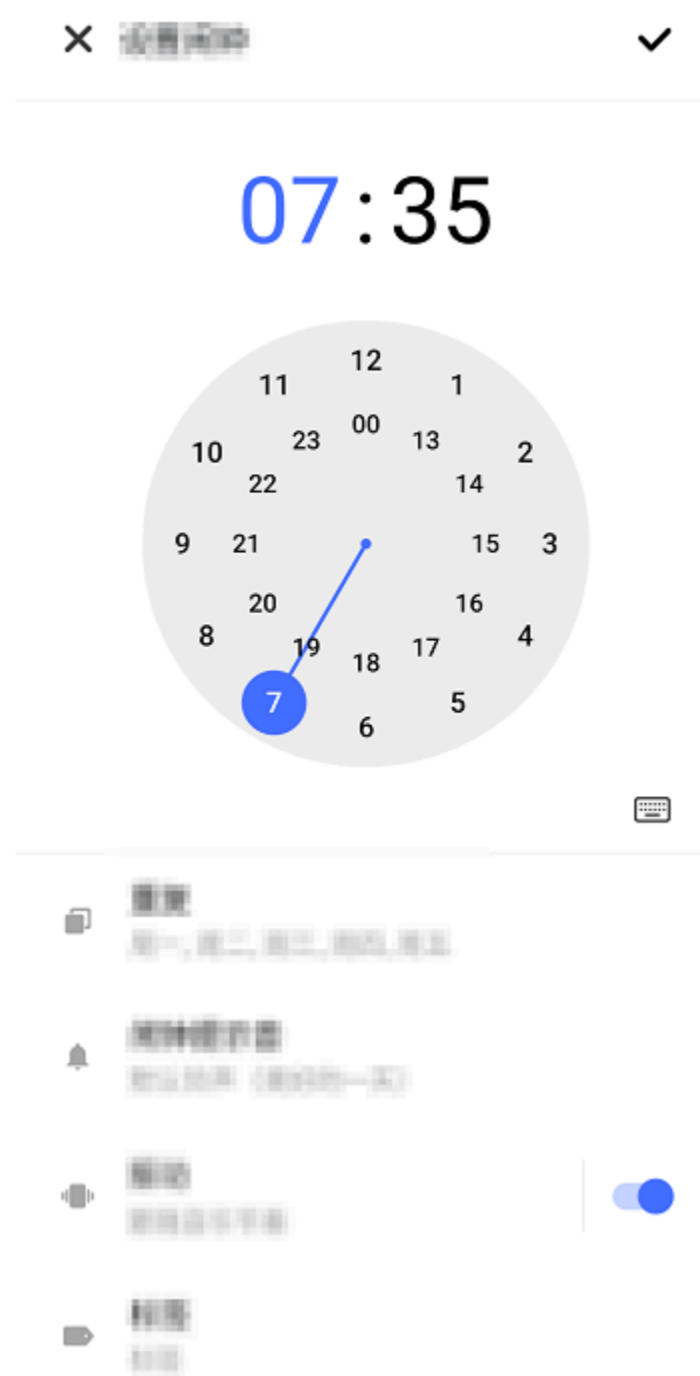



Note

The illustration is for reference only. Some options may not be available on specific models.

Tap the following icons for more settings:

: On the digital clock: Enter the hour and minutes you want.

: On the analog clock: Slide the hour hand to the hour you want and then slide the minute hand to the minutes you want.

: To make the alarm repeat, tap the days of the week. If not set, the alarm will go off once by default.

: Pick a sound for the alarm.

: Set your device to vibrate when the alarm goes off.

: Alarm label. Give the alarm a name.

: Turn off the alarm.

: Save the alarm.

• Delete an alarm

Method:

1. From the Alarm tab, tap  > **Select**, or tap and hold the alarm.

2. Select the alarm to be deleted or tap  to select all alarms.

3. Tap .

• Turn on or off an alarm

To turn on or off an alarm, toggle on or off the switch next to it from the Alarm tab.

View clocks for other cities

Clock lets you keep track of the local time in different time zones around the globe and convert the time difference.



• Add clocks for other cities

To add a city:

1. From the Clock tab, tap .
2. Select the cities you want to add.

• Remove a city

Method:

1. From the Clock tab, tap  > **Select**, or tap and hold the city.
2. Select the city you want to remove or tap  to select all.
3. Tap .

Note

The clock for the city where you reside can't be deleted.

• Time converter

Method:

1. From the Clock tab, tap  > **Time converter**.
2. Select the cities you have added.
3. Select the date and time on the clock, and the local time for the cities listed will be automatically updated.

Note

Time converter appears only when more than one city has been added.

Set a timer

Timer allows you to count down from a specified time.

Method:

1. From the Timer tab, enter a time.
2. Tap  to start the timer.

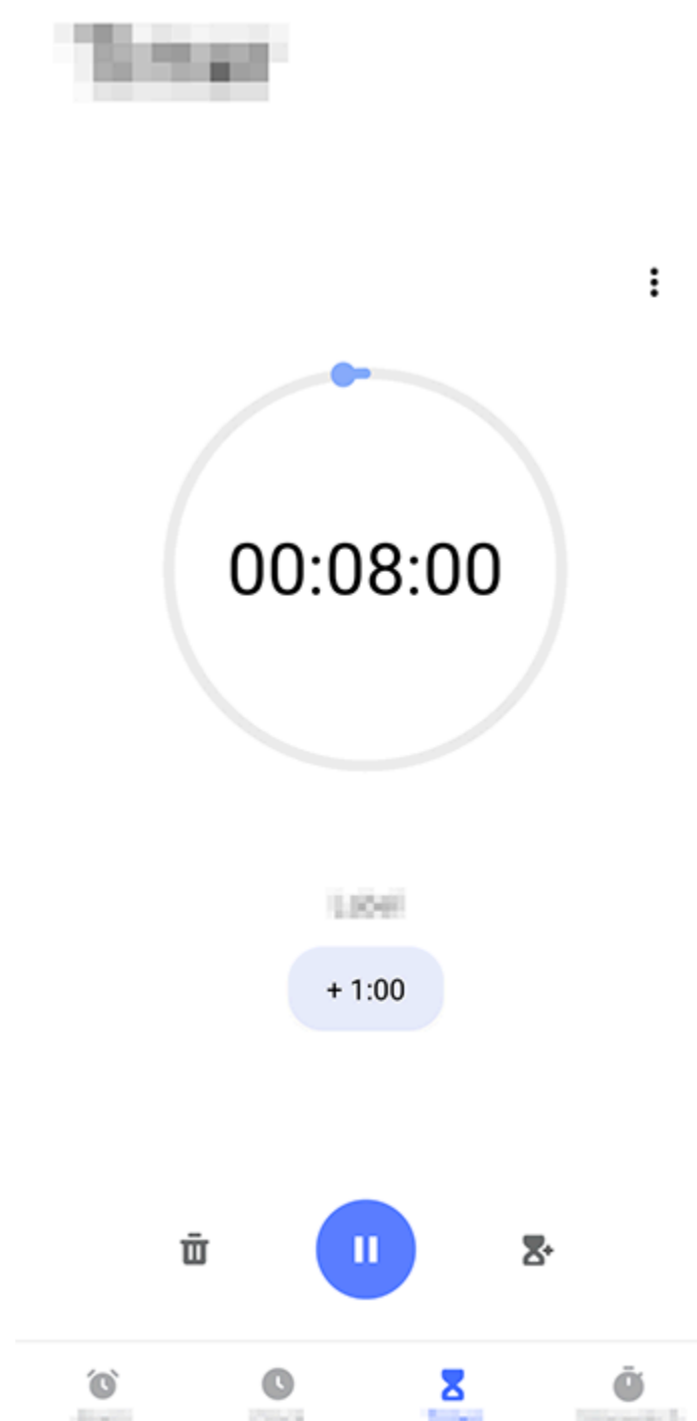



Note

The illustration is for reference only. Some options may not be available on specific models.

Tap the following icons for more settings:

: Delete the timer.

: Enable multiple timers at the same time.

: Add a minute to the timer. Tapping  during the countdown will bring up **Reset**. Tap **Reset** to restart the timer.





: Pause the timer.

: Resume the timer.

Enable stopwatch

Stopwatch lets you measure the duration of an event.

Method:

1. From the Stopwatch tab, tap  to start timing.
2. Tap  to record a lap, tap  to pause a running stopwatch, and tap  to reset a stopwatch.
3. Tap  to share or copy the lap data.

More settings

For more settings in Clock, tap  > **Settings**.

Compass

 **Tip: Whether the app is supported on a certain device and what features are available may vary by device model, carrier, and country/region. Please contact your distributor or service provider for more information.**

You can use the Compass app to find directions, learn about your current latitude and longitude, determine whether an object is level, and more. To access Compass, tap  on the home screen.

View bearings as well as latitude and longitude

To view your bearings as well as your current latitude and longitude, go to **Compass**.



276°
West

N 22°34'13.45" E 114°3'19.61"

Level measurement

To measure the angle of inclination of an object:

1. Open **Level**.

2. Hold your device against the object.
3. Check the angle of inclination displayed on the screen.

Note

1. Before using this feature, make sure your device is positioned horizontally and not exposed to any electromagnetic interference, so as to get accurate results.
2. To view your current location, enable the network connection and location services first.
3. Once disturbed, the Compass will automatically switch to the calibration screen. Upon calibration, the direction can be realigned.
4. Use the digital compass only for basic navigation assistance. Do not rely on it to determine a precise location, proximity, distance, or direction.

Game Space

 **Tip: Whether the app is supported on a certain device and what features are available may vary by device model, carrier, and country/region. Please contact your distributor or service provider for more information.**

Game Space

View the games installed on your device, the time you have recently spent on games, or other data here.

Method:

1. Go to **Game Space**.
2. Do any of the following:
 - Swipe on the cards to view installed games and tap a card to quickly start the game.
 - Tap **Game data** to view the time you have spent on each game and the total duration in the past 7 days.

Themes

 **Tip: Whether the app is supported on a certain device and what features are available may vary by device model, carrier, and country/region. Please contact your distributor or service provider for more information.**

Tap  to access the **Themes** app, where you can customize wallpapers, themes, fonts, and more.

Note

You must connect your device to the internet to use this feature.

Download and apply new themes, fonts, wallpapers, Always On Display styles, and more

Method:

1. Go to **Themes > Recommended** or **Category**.
2. Select the themes, fonts, wallpapers, and Always On Display styles you prefer.
3. After entering the details page, do the following:
 - For free resources, tap **Download > Apply**.
 - For paid resources, tap **Free trial** or **Purchase now**.

Note

Sign in to your account before trying or purchasing paid resources.

View local themes, fonts, wallpapers, or Always On Display styles

To view the wallpapers, themes, fonts, and other resources that are preloaded or downloaded on your device, go to **Themes > Me** to explore them on the **Local themes, Local fonts, Local wallpapers, and Local Always On Display styles** pages, respectively.

More Themes settings

- To change the home screen wallpaper or lock screen wallpaper with the theme, go to **Me > Settings** to enable **Change home screen wallpaper based on theme** or **Change lock screen wallpaper based on theme**, respectively.
- To update resources over Wi-Fi, go to **Me > Settings** to enable **Auto-update resources over Wi-Fi**.
- To allow Themes to intelligently recommend content that may be of interest to you, go to **Me > Settings** to enable **Personalized recommendations**.

Music

 **Tip: Whether the app is supported on a certain device and what features are available may vary by device model, carrier, and country/region. Please contact your distributor or service provider for more information.**

To play music stored on your device or music streamed over the internet, tap  on the home screen.

Play music

• Playback bar





To play music, select a song by going to **Music > Lists/Songs/Artists/Albums**. The playback bar will be shown at the bottom of the screen.



Note

The illustration is for reference only. Some options may not be available on specific models.

Tap the following icons as needed:

-  : Play this song.
-  : Pause this song.
-  : Skip to the next song in an album or playlist.
-  : Open the playlist.

• Music playback screen

Tap the playback bar to access the playback screen.

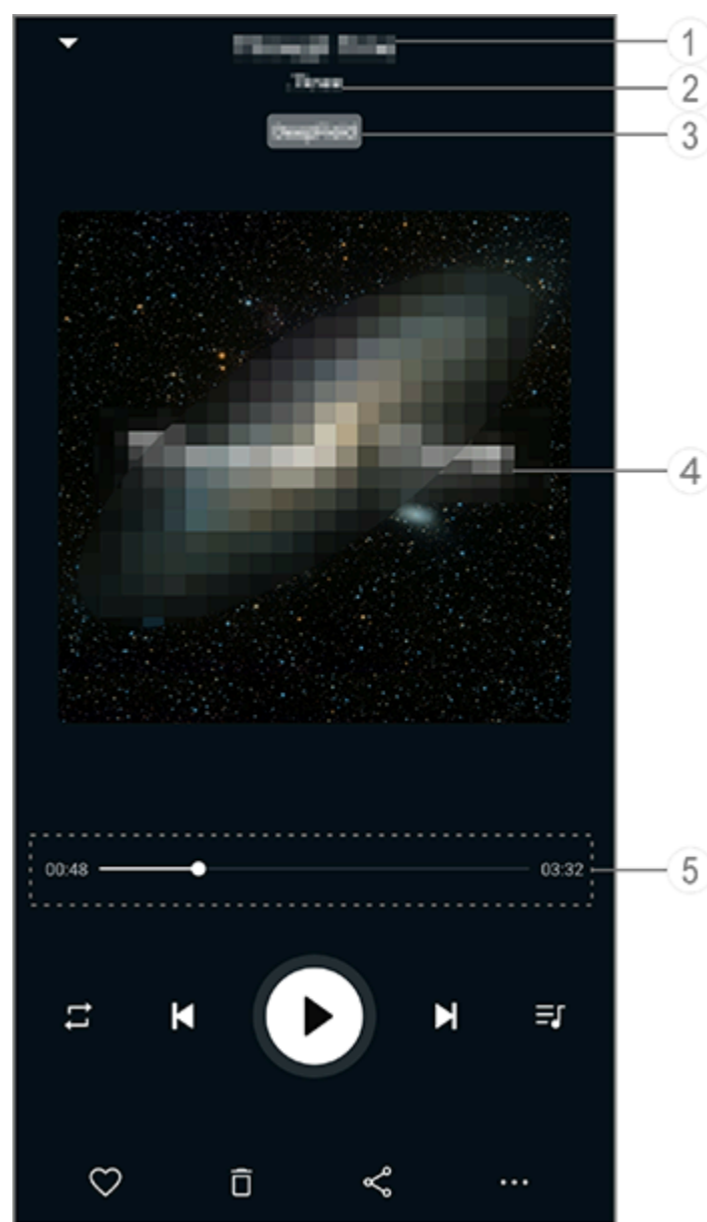

Note

The illustration is for reference only. Some options may not be available on specific models.

- ① Song name.
- ② The artist of this song.
- ③ Set deep space sound profiles (available in earphone mode only).
- ④ The cover image of this song. Do any of the following:
 - Tap to view the lyrics.
 - Tap and hold the lyrics to edit, share, or save the lyrics poster.
- ⑤ Playback progress bar.

See the table below for the description of each icon.

	Drag to adjust the playback progress
	Play songs in random order
	Play all songs in loop
	Repeat this song
	Go back to the previous song
	Start/Resume playback
	Pause playback
	Skip to the next song
	Current playlist
	Add this song to Favorites
	Delete this song
	Share this song
	More options, such as adding the song to a playlist or setting it as a ringtone (available in some countries)

	Back

Manage albums

To view an album, tap **Albums** from Music.

You can also do any of the following:



- Edit an album: Access an album, tap  to select a song, and then tap **Add to playlist** or **Delete** to add it to a playlist or delete it.
- Delete an album: Tap and hold an album to select it, and then tap **Delete**.
- Add to playlist: Tap and hold an album to select it, and then tap **Add to playlist**.

View or manage recently played songs

To view or manage recent playlists, go to **Lists > Recently played**.

• Delete recently played songs

If you want to delete recently played songs, use the following method:

- Tap and hold a song you want to delete, and then tap .
- Tap  to select the songs you want to delete, and then tap .

• Share recently played songs

Method:

1. Tap and hold a song you want to share, and then tap **Share**.
2. Select a sharing method to share the song.

Create playlists to manage songs

To manage or sort the songs on your device, go to **Lists** to create a new playlist.



• Create a new playlist

Method:

1. Tap **New playlist** from **Lists**.
2. Enter the name of the new playlist and tap **Save**.
3. To rename a custom playlist, tap and hold it, and then tap .





• Add a song to a playlist

If you want to add a song to a playlist, use the following method:

- Open the custom playlist, tap  to select a song, and tap **Add to playlist**.
- Tap and hold the song you want to add to a playlist, and then tap .

• Remove or delete a song from a playlist

If you want to remove or delete a song from a playlist, use the following method:

- Open a custom playlist, tap and hold the song you want to remove or delete, and then tap  or .
- Open a custom playlist, tap  to select the songs you want to remove, and then tap .

• Delete a playlist

To delete a playlist, tap and hold the custom playlist you want to delete, and then tap .

Search for songs stored on your device, artists, and albums

Quickly locate a song stored on your device, or find an artist or album by searching with keywords.





Method:

1. Tap  to go to the search screen.
2. Enter the keywords of the song, artist, or album in the search bar.

Features on the Songs screen

To play a song stored on your device, go to **Songs**.



Tap and hold a song and then do any of the following:

- Tap  to delete the song.
- Tap  to share the song.
- Tap  to add it to a playlist.
- Tap  to set it as a ringtone (available in some countries).
- Tap  to view or edit the information on the song.

Features on the Artists screen

To view all songs or albums of an artist stored on your device, go to **Artists**.

Tap and hold an artist and then do any of the following:

- Tap  to delete the artist.
- Tap  to add it to a playlist.

More features



• Scan your device for songs

To scan the songs on your device, tap  > **Scan for songs** > **One-tap scan**.

• Enable or disable Sleep mode

Stop playing music after the countdown ends.

Method:

1. Tap  > **Sleep mode**.
2. Drag  to set a duration.
3. Tap **Enable** to enable this feature.
4. Tap **Disable** to disable this feature.

• Set various sound profiles

To select a sound profile, go to  > **Sound profile settings**.

- **Deep space:** Create an immersive listening experience.
- **Featured:** Enjoy a variety of sound profiles.
- **Equalizer:** Optimize sound profiles.
- **Earphone-customized:** Optimize the sound profiles in earphone mode.
- **Ear-customized:** Enjoy a better experience during music or video playback with custom sound profiles.

Note

Some features are available in earphone mode only.

Weather

Tap  to access the **Weather** app, where you can view the upcoming weather conditions.

Note

You must connect your device to the internet to use this feature.

Manage cities

• **Add a city**

To check the weather in another city, add the city by using location services or searching for it.

To add a city:

- Enter the city name in the search bar.
- Tap **Add current location**.
- Access a city on your weather list, and then tap  > **+**.





Note

If you are using the Weather app for the first time or have not added your current city, you can add a city with the location services.

• **Reorder cities**

To reorder the cities on your weather list:

Method:

1. Tap  from the weather screen of a city on your weather list.
2. Tap .
3. Tap and hold  and drag it to the required position.
4. Tap .

• **Delete a city**

To delete a city on your weather list:

Method:

1. Tap  from the weather screen of a city on your weather list.
2. Tap and hold the city that you want to delete.
3. Tap **Delete**.

Options on the weather screen



⚠️ Note

The illustration is for reference only. Some options may not be available on specific models.

① City name.

② Current temperature.

To change the temperature unit, tap  > **Settings** > **Temperature unit**.

③ Current weather condition.

④ High and low temperatures of the day.

⑤ Swipe on the weather curve to see the temperature changes and weather conditions for the next 22 hours.







⑥ Temperature changes and weather conditions for the next 14 days.

To display the weather conditions for the coming days in a different format, tap  > **Settings** > **Multi-day forecast format**.

• More options in Weather

To view other weather information of a certain city, scroll up on the weather screen.

See the table below for what each icon means.

	Apparent temperature
	Wind direction/Wind force
	Atmospheric temperature
	UV index
	Visibility
	Atmospheric pressure
	Sunrise/Sunset

Add a Weather widget to your home screen

To check the weather and time of a certain city on your home screen:

Method:

1. Tap  from the weather screen of a city on your weather list.
2. Tap **Settings > Home Screen Weather**.
3. Tap and hold the city that you want to add.
4. Tap **Add**.

Note

When the selected city is different from your current city, the weather and time of both cities will be displayed on the widget.

Share a city's weather conditions with others

Method:

1. Tap  from the weather screen of a city on your weather list.
2. Tap **Share**.
3. Select a picture style that you want to share.
4. Select a sharing method and share the weather as required.

EasyShare

To access **EasyShare**, tap  from the Apps screen or on the home screen. With this feature, you can transfer files between devices and migrate data from your old phone to a new one at a high speed without consuming any data.

Basic features of EasyShare

• **Connect to another device via Smart Scan**

To use the File transfer or Phone clone feature, you need to connect to another device. To do so, tap  on your home screen to scan the QR code on that device.



Method:

1. Show the generated QR code of the device that you want to connect to.
2. Tap  on the EasyShare home screen on your device.
3. Use your device to scan the QR code of the former device.

• **View the files sent to or received from other devices**

With this feature, you can view or delete the files sent to or received from other devices.

Method:

1. Tap  on the EasyShare home screen on your device.
 2. View or delete a file as needed.
- Tap  to filter files by type.
 - To delete a record or file, tap  to select it, and then tap **Delete record** or **Delete record and file**.

Before using File transfer or Phone clone

• **Share EasyShare with another device**

If you want to transfer files or migrate data to a device that doesn't have EasyShare installed, tap **Share EasyShare** on the main screen.

· To **share via Bluetooth**:

1. Tap **Share via Bluetooth**.
2. Select the Bluetooth-enabled device.
3. Send EasyShare.

· To **share via Wi-Fi**:

1. Enable the Wi-Fi feature on the device that you want to connect to.
2. Connect the device to your device by using hotspot.
3. Enter the URL on another device or use it to scan the QR code on your device.

 **Note**

For the URL or QR code, go to the **Share via Wi-Fi** page of your device.

• **Download EasyShare online**

If you want to transfer files or migrate data to a device that doesn't have EasyShare installed, you can also try the following methods.

· To download EasyShare by scanning a QR code:

1. Generate a QR code on your device via **EasyShare > Share EasyShare**.
2. Enable internet connection on the peer device and scan the QR code.

· To download EasyShare from the official channel:

1. Enable internet connection on the peer device.
2. Download EasyShare from the official channel.

 **Note**

1. For the website or QR code, go to **EasyShare > Share EasyShare** on your device.
2. You must connect your device to the internet to use this feature.

• **Back up your data before file transfer**

To transfer files or migrate data to another device, you can back up your data first to prevent data loss.

Method:

1. Open the EasyShare URL on a PC.
2. Download and install the EasyShare on the PC.
3. Back up or manage your data through either of the following ways:
 - Connect your phone to your computer with a USB cable to perform backup or restoration.
 - Connect your phone to your computer over a Wi-Fi to perform backup or restoration.

 **Note**

1. For the official website, go to **EasyShare > Data backup** on your device.
2. You must connect your device to the internet to use this feature.

Send or receive files

Tap **File transfer** to receive or send files at a high speed without consuming any data. You can simultaneously transfer various types of files.

Take Android-powered devices for example:

• **On the sending device:**

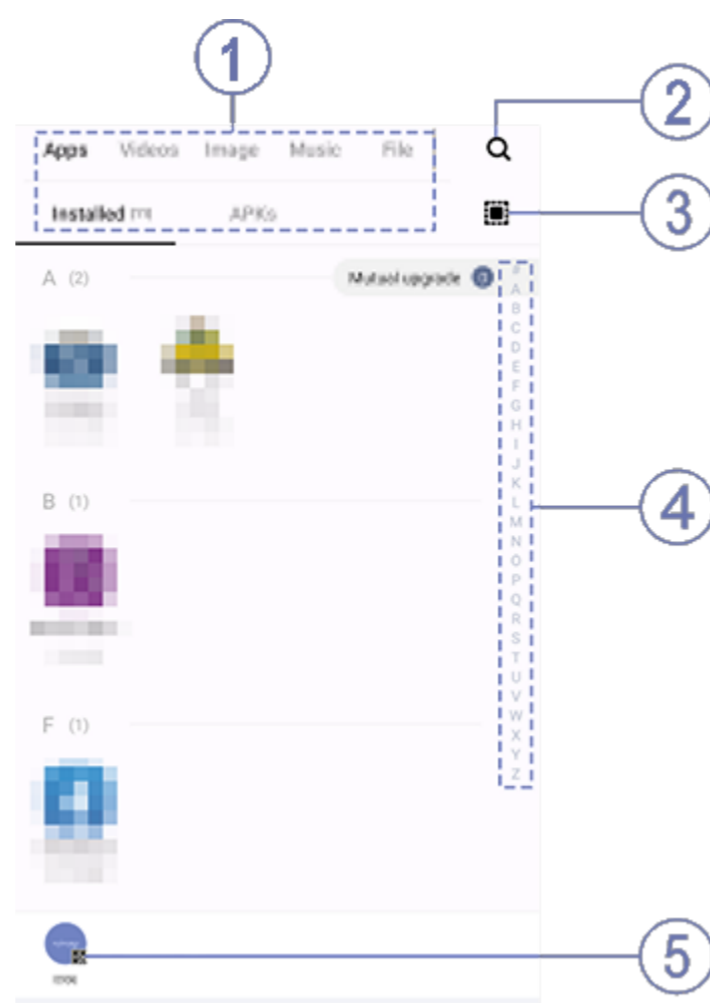

1. Tap  on the sending device.
2. Select files.



Note

The illustration is for reference only. Some options may not be available on specific models.

You can select files in a variety of ways, as shown in the image above:

- ① Select files by type.
- ② Tap  to search for specific files.
- ③ Tap  to select all files.
- ④ Swipe up or down on the index bar to quickly select files you need.

3. Tap the position ⑤ to show the QR code.

4. Display the QR code to the receiving device for it to scan so as to pair up with the sending device.

5. Tap **Send**.

• **On the receiving device:**

1. Tap  on the home screen of the receiving device.
2. Scan the QR code on the sending device to connect to it.
3. Accept File transfer.

Clone data from the old device to the new device with one tap

Tap **Phone clone** to migrate data of any kind from your old phone to a new one without consuming any data.

Assume the current phone is a new phone. The method is as follows:

• **On the old phone:**

1. Tap  on the old phone.
2. Display the QR code.
3. Use the new phone to scan the QR code of the old phone to pair them.
4. Select files to clone.
5. Tap **Start cloning**.

• **On the new phone:**

1. Tap  on the new phone.
2. Select the type of the old phone (iPhone or Android).
3. Scan the QR code of the old phone to pair up with the old phone.
4. Accept File transfer.

Note

1. If the old phone is an iPhone, make sure EasyShare has been installed before transferring files.
2. When file transfer is complete, the data of the same apps on the new phone will be overwritten.

Other features of EasyShare

To sign in to your account and change your profile picture, tap the profile picture on the main screen.

Sign in to your account

Method:

1. Tap the profile picture on the main screen of your device.
2. Tap **Sign in**.
3. Select the type of the account that you want to sign in to.
4. Enter the account name and password to sign in to the account.

• Change your profile picture and nickname

Method:

1. Tap the profile picture on the main screen of your device, and then tap the profile picture again on the screen that appears.
2. Do any of the following:
 - To change the color of the default profile picture, select from color options that come with your phone.
 - To change the default profile picture, tap  to select one from Albums or take a new photo.
 - To change the default nickname, enter a new one in the input box.
3. Tap **Save**.

Note

Depending on the sign-in option you choose, the options available when changing the profile picture or nickname may vary, subject to your device.

• View the weekly report on file transfers

Method:

1. Tap your profile picture on the main screen of your device.
2. Tap **Weekly summary**.
3. View the report of this week.

Note

The report covers the transfers made within the current week only. If no transfers have been made within the past week, no weekly report will be generated.

• Upgrade EasyShare without data consumption

To upgrade EasyShare without consuming any data, follow the method below:

Method:

1. Tap your profile picture on the main screen of your device.
2. Tap **Settings**
3. Enable **Data-free auto upgrade**.

Note

Once a connection is established between two devices, this feature compares the versions of EasyShare installed on these devices, and upgrades the lower version to match the higher version without consuming data, ensuring both devices are running the same or the latest version of EasyShare.





Notes

⚠️ Tip: Whether the app is supported on a certain device and what features are available may vary by device model, carrier, and country/region. Please contact your distributor or service provider for more information.

You can use Notes to keep track of your inspiration and thoughts. To access it, tap  on the home screen.









Create a note

To create a note:

1. From , tap ; or open a folder from , and then tap .
2. Save a note and tap .







Options in Notes

Open a note in full screen and tap the following icons as needed:

	Change the font size or text formatting
	Add a to-do list
	Change the status of a to-do list item
	Set a reminder
	Insert an image
	Create a voice note
	Change a note's background or add a table to the note
	Undo or redo edits

• Change the font size or text formatting

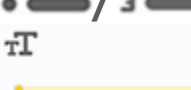



To change the font of a note, tap  and perform one of the following operations:

- : Embolden the text.
- : Italicize the text.
- : Underline the text.
- : Strike through the text.
- : Highlight the text.
- : Switch between bulleted and numbered lists.
- : Drag the slider to adjust the font size.

• Add a to-do list

Organize your life efficiently by creating a to-do list with Notes.



Method:

1. Tap .
2. Enter your text, and then tap  or  to change the status of the to-do list item.
3. Tap .

• Set a reminder

Jot down your to-dos with Notes and schedule reminders to ensure timely completion.







Method:

1. Tap .
2. Select a specific date and time for the reminder.
3. Tap .

• Insert an image

Insert images into your notes to make them more engaging.



Method:

1. Tap .
2. Select from the following options as needed:
 - If you select , take a desired picture and tap **OK**.
 - If you select , select a desired picture and tap .
 - If you select , draw graffiti and then tap .
3. Tap .

• Create a voice note

When it is not convenient to take notes, rely on voice notes to get the job done.

Method:

1. Tap .
2. Tap  to pause recording or  to stop recording during recording.
3. Tap .

• Change the background

To change a note's background, tap  > **Skin** to select a skin you prefer.

• Insert a table

To insert a table in a note, tap  > **Table**, enter your text, and then tap  to save the note.

Flag a note

To flag a note, open it in full screen and tap .

Search for a note

To quickly locate a note, tap  from  or .

Personalize a note

To personalize your note, tap  > **Settings** from  or .

Pin a note

To pin a note:

1. Tap and hold the note in the list of notes.
2. Tap **Pin**.

Encrypt/Decrypt a note

• Encrypt a note

You can encrypt a note by using the following method:

- Tap and hold the note in the list of notes, and tap **Encrypt**.
- Open the note in full screen and tap .

To set a password for a note:

1. Tap .
2. Tap **Password options** to select a password type.
3. Set a password based on screen prompt.

• Decrypt a note

You can decrypt an encrypted note by using the following method:

- Tap and hold the note in the list of notes, and then tap **Decrypt**.
- Open the note in full screen and tap .

Note

After decrypting a note, you need to reset the privacy password when encrypting it again.

Share or save a note

Open the note in full screen and tap  to save or share it with others.

Delete a note



To delete one or more notes:

- Tap and hold a note, and then tap **Delete**.
- Tap  in the list of notes, select one or more notes, and then tap .
- Open the note in full screen and tap  > **OK**.

• Recently deleted notes

To view recently deleted notes, tap  > **Settings** > **Recently deleted** from  or .

To permanently delete a note or to restore a note:

- Tap and hold the note, and select **Permanently delete** or **Restore** in the pop-up window.
- Open the note and tap  or .

Note

Content in Recently deleted will be kept for only 60 days before being permanently deleted.

Browser

 **Tip: Whether the app is supported on a certain device and what features are available may vary by device model, carrier, and country/region. Please contact your distributor or service provider for more information.**



Tap  to access the **Browser** app, where you can browse the web, search the web for specific information, and more.

Note

You must connect your device to the internet to use this feature.

Search the web for specific information

To search the web for specific information from :



- Enter search keywords in the search bar.
- Tap  to scan for what you want.
- Tap  to enable voice search.

View and edit browsing history and bookmarks

Use this feature to view and edit browsing history and bookmarks.



• View and edit bookmarks

Method:

1. Go to  >  > **Bookmarks/History** > **Bookmarks**.
2. Perform one of the following operations:
 - To delete a URL, tap and hold it, and then tap **Delete bookmark**.
 - To reorder URLs, tap **Select** and tap and hold  to drag them to the desired positions.

• View and edit browsing history







Method:

1. Go to  >  > **Bookmarks/History** > **History**.
2. Perform one of the following operations:
 - To delete a URL, tap **Select**, select the URL, and then tap **Delete**.
 - To delete all history, tap **Clear all**.

Incognito

You can use Incognito mode to visit websites without them appearing in your browsing and search history.

Method:

1. Go to  > .
2. Tap  **Incognito**.
 is displayed in the lower part of the page, indicating that Incognito mode is enabled.
3. Tap  >  to exit Incognito mode.

Note

In Incognito mode, you can't take screenshots or record the screen in Browser.

Tips

 **Tip:** Whether the app is supported on a certain device and what features are available may vary by device model, carrier, and country/region. Please contact your distributor or service provider for more information.

To learn more about some new interesting features, go to Tips, where you can browse useful tips and tricks by section.

Note

You must connect your device to the internet to use this feature.

V-Appstore



Tap  on the home screen to browse recommended apps and download them without signing in.

Note

You must connect your device to the internet to use this feature.

Search for apps

To search for an app:

1. Tap  in the top part of the screen.
2. Enter the app name in the search bar.
3. Tap .

Download apps

To download and install an app, tap **Install** next to it.

• Manage downloaded apps

To manage the apps downloaded to your device:

- Tap .
- Tap  > **Download management**.

App rankings

To view or switch between app rankings, tap .

Personal management

To manage apps or sign in to your account, go to .

• Update apps

To update apps, go to  > **App updates** and update apps based on your requirements:

- To update all apps, tap **Update all**.
- To update some apps, tap **Update** next to the apps.
- To ignore updates, tap  > **Ignore** next to the apps.

• **Uninstall apps**

To uninstall an app:

1. Tap .
2. Select the app that you want to uninstall.
3. Tap **Uninstall**.

• **Clean up space**

To clean up the residual data on your device, tap **Space cleanup**.

• **Help & feedback**

To access FAQ and give feedback, go to **Help & feedback**.

• **More settings**

To configure more settings for V-Appstore, tap .

Video

 **Tip: Whether the app is supported on a certain device and what features are available may vary by device model, carrier, and country/region. Please contact your distributor or service provider for more information.**

This app will automatically scan your device for videos and display them. To access Video, tap  on the home screen.

Play a video



To play a video stored on your device:





1. Go to **Videos** or **Folders**.
2. Tap a video to play it.

Options during playback

During video playback:



- Swipe up or down on the screen to adjust the volume and brightness.
- Tap the screen to show or hide the control buttons. Tap the following icons as needed:

	Mirror the video to another device
	Set the video playback size, speed, and more
	Lock the screen orientation during video playback

	Play previous/next video
	Pause playback
	Take a screenshot during video playback
	Play the video in a floating window
	Rotate the video



Share a video

To share a video with others, go to **Videos** or **Folders**, and then do any of the following:

- Tap and hold a video, and then tap .
- Tap to select a video, and then tap .



Delete a video

To delete a video, go to **Videos** or **Folders**, and then do any of the following:

- Tap and hold a video, and then tap .
- Tap to select a video, and then tap .

Rename a video

To rename a video, go to **Videos** or **Folders**, and then do any of the following:

- Tap and hold a video, and then tap .
- Tap to select a video, and then tap .

Reorder videos

To reorder the files in the list of videos:

1. In the list of videos, tap  > .
2. Select a preferred sorting method.

Search for a video

To quickly locate a video:

1. In the list of videos, tap .
2. Enter keywords in the search bar.

Google apps

Google provides a variety of entertainment apps, social media apps, and other apps. To use certain apps, you may need to sign in to your Google account. Visit the Help page of each app to learn more.

Google services

Chrome/Google: Search for information and browse the web.

Gmail: Send or receive emails.

Maps: Locate yourself and access other location-based information, such as nearby recreational and entertainment venues.

YT Music: Browse and stream music or videos stored on your device.

YouTube: Watch videos shared by others, or upload your own.

Photos: Manage and edit all photos and videos stored on your device.

Google Assistant: Make calls, plan routes, and perform other tasks using your voice.

Google Meet: Make video calls.

Files by Google: View or manage files, apps, and other data stored on your device.

Google Pay: Make mobile payments securely and efficiently by storing your card details.

Calendar: View dates, set event reminders, and more.

Play Store: Search for and download the latest Android apps, games, movies, music, and more.

Phone: Make and answer calls.

Contacts: Add and save contacts.

Messages: Send and receive files such as SMS messages, photos, videos, or audio files.

Note

1. Some apps may not be available or may vary in features depending on your region and service provider.
2. You must connect your device to the internet to use some features.

Messages



 **Tip: Whether the app is supported on a certain device and what features are available may vary by device model, carrier, and country/region. Please contact your distributor or service provider for more information.**

To view or send messages, tap  on the home screen.

Send messages













You can send messages when not available for calls.

Method:

1. Go to Messages and tap .
2. Enter message content.
3. Enter the phone number of the recipient in the **Recipient** box.
4. Tap .

Overview of New message screen

To send MMS messages, tap **+** and then tap the icons below as needed:

	Insert an image
	Take a photo
	Insert a contact
	Scheduled messages
	Insert a video
	Shoot a video
	Insert a recording file
	Switch between SMS and MMS
	Insert a note
	Insert a ringtone
	Insert a file
	Insert a slide
	Insert a bookmark

Search for messages



To quickly locate a message from list of messages:

Method:

1. Tap .
2. Enter a keyword.
3. Select the message that you want.



Forward messages

To forward a message:

- Tap and hold the message, and then tap **Forward**.
- Tap  to select the message, and then tap .

Call the sender of a message

To call the sender of a message:

- Swipe left over the message, and tap .
- Open the message in full screen, and tap .

Add the sender of a message to Contacts/blocklist

To add the sender of a message to Contacts/blocklist:

- From the list of messages, tap and hold the message, and then tap **Add to Contacts** or **Add to blocklist**.
- From the full-screen view of the message, tap  > **Add to contacts** or **Add to blocklist**.

Note



You will not receive any phone calls or messages from the contact once it is added to the blocklist.

Delete messages

To delete a message from the list of messages:

- Tap and hold the message, and then tap **Delete**.
- Swipe left over the message, and tap .

To delete a message in the full-screen view:

- Tap and hold the message, and then tap **Delete**.
- Tap  to select the message, and then tap .



Block unwanted messages

If you do not want to receive messages from certain contacts, you can block them by going to  > **Block unwanted messages**.

• **Add to blocklist**

To block calls or messages from a certain number, add it to the blocklist.

Method:

1. Go to **Blocklist**.
2. Tap .
3. Select numbers to block.
4. Tap .



• **Set whether to receive notifications for blocked messages**

To set whether to receive notifications when messages are blocked:

1. Tap **Blocking notification**.
2. Select a notification type.

• **Delete blocked messages**

To delete a blocked message from **Blocked messages**:

- Tap and hold the message, and then tap **Delete**.
- Tap  to select the message, and then tap .







Phone

⚠️ Tip: Whether the app is supported on a certain device and what features are available may vary by device model, carrier, and country/region. Please contact your distributor or service provider for more information.

To make or answer a call, tap  on the home screen.

Make a call

Method:

1. Open .
2. Select a contact in the following ways:
 - Enter a number on the keypad and tap .
 - Enter the first few letters of the contact's name to quickly pull up the contact.
 - Tap a contact from call logs.
 - From , swipe a contact to the left, and then tap .
 - From , tap a contact and then tap .

⚠️ Note



To bring up the keypad, tap .

Answer or reject a call

Follow the instructions below to answer or reject a call.



• Answer a call

To answer a call:

- On the incoming call full screen: Swipe down when the screen is locked.
- On the incoming call full screen: Tap  when the screen is unlocked.
- On the incoming call pop-up screen: Tap .





• Reject a call



To reject a call:

- On the incoming call full screen: Swipe up when the screen is locked.
- On the incoming call full screen: Tap  when the screen is unlocked.
- To reject the call and reply with a message, tap  on the incoming call full screen.
- On the incoming call pop-up screen: Tap .

Action icons while on a call

Refer to the table below to understand the action icons during a call.

	Record the ongoing call
	Put the ongoing call on hold
	Mute the microphone
	Make another call while a call is in progress

	Make a video call
	Enable speakerphone
	Expand/Hide keypad

Note

1. Whether the app is supported on a certain device and what features are available may vary by device model, carrier, and country/region.
2. If you can't find a certain option on your device, it means the feature is not supported.

Phone settings

To configure settings associated with the Phone app, go to  > **Call settings**.

- To reject messages or calls from certain contacts, tap **Block spam calls**.
- To customize the reject messages, tap **Reject with SMS**.
- To set your phone to vibrate when your call is answered or hung up, tap **Vibrate on answer/hang up**.
- To make a quick call by tapping and holding a number key, tap **Speed dial** to assign a contact to a number.
- To keep calls in pop-up or full screen when the screen is unlocked, tap **Call display when unlocked**.

Contacts

 **Tip: Whether the app is supported on a certain device and what features are available may vary by device model, carrier, and country/region. Please contact your distributor or service provider for more information.**

To create or manage contacts, tap  on the home screen to access the Contacts app.

Import contacts

To import contacts to your device:

- Tap **Import from storage device**, and the selected contacts data will be imported to your device automatically.

Note

This feature is available only when the Contacts list is empty.

- Tap **Import from cloud storage**, sign in to access **Contacts**, and then tap **Restore** to sync the backed-up contacts data to your device.

Note

1. This feature is available only when the Contacts list is empty.
2. You must connect your device to the internet to use this feature.

· Go to  > **Contacts settings** > **Import/Export** > **Import from storage device**, and the selected contacts data will be imported to your device automatically.

Create contacts

Method:

1. Tap .

2. Do any of the following:

· To set a profile picture for the contact, tap  > **Choose photo** or **Take photo**, take or choose the required photo, and then tap .

· To enter information such as the name and phone number of the contact, tap the corresponding fields.

3. Tap .

Edit contacts

Edit contacts in either of the following ways:

Method 1:

1. Tap a contact.

2. Tap .

3. Modify the information and tap .

Method 2:

1. Tap .

2. Enter the name of the contact, and locate the exact contact to be edited from all the matching contacts.

3. Tap **OK**.

4. Modify the information and tap .

Merge duplicate contacts

Merge contacts with duplicate names or phone numbers.

Method:

1. Tap  > **Contacts** > **Merge duplicate contacts**.

2. Select contacts who you want to merge or tap  to select all contacts.

3. Tap .

Note

This feature only works for contacts stored in the same location.

Share contacts

To share a contact with others:

· Tap a contact, and then tap **QR code name card** to generate a QR code for other devices to scan.

· Tap a contact, and then go to  > **Share** > **As text** or **As attachment**.



· Tap and hold a contact, tap **Share**, and select a sharing method.

Delete contacts

Delete a single contact or multiple contacts in any of the following ways:

Method 1:

1. From Contacts, tap .

2. Select one or more contacts to delete or tap  to select all.
3. Tap  > **Delete**.

Method 2:

1. From Contacts, tap a contact.
2. Tap  > **Delete contacts** > **Delete**.

Method 3:







1. From Contacts, tap and hold a contact.
2. Tap **Delete** > **Delete**.

• **View recently deleted contacts**

You can either restore the deleted contacts or permanently delete the contacts.

1. From Contacts, tap  > **Contacts settings** > **Recently deleted**.

2. Do any of the following:





- To permanently delete the contacts, tap  to select one or more contacts or tap  to select all contacts, and then tap  > **OK**.
- To restore the deleted contacts, tap  to select one or more contacts or tap  to select all contacts, and then tap .
- To disable Recently deleted, tap  > **Disable Recently deleted**.

Note

1. This feature only works for contacts stored on your device.
2. Content in Recently deleted will be kept for 30 days before being permanently deleted.

Favorite contacts

You can mark frequent contacts as favorites to easily access them from **Favorites**.

- Tap  > , select one or more contacts or tap  to select all contacts, and then tap **Add**.
- From Contacts, tap .

Search for contacts



To quickly locate a contact from a list of contacts:

- From Contacts, tap the contact's initials from the index on the right.
- From Contacts, tap , and enter the name or phone number of the contact in the search bar.

Export contacts

Export contacts from your device in the following way:

Method:



1. Tap  > **Contacts** > **Import/Export** > **Export to storage device**.
2. Select contacts who you want to export or tap  to select all contacts.
3. Tap **Export** > **Save**.

Manage contact groups

You can use the **Groups** feature to organize your contacts by company, contact time, or other attributes. You can also send messages to members of a group or set a unique ringtone for the group.











• **Create groups**

Method:

1. To create a group: Tap  > , enter a group name, and tap **OK**.
2. To add members: Select contacts to add to the new group, and then tap .

• **Edit groups**

From :

- To add contacts, select a group, and then tap  to select the contacts you want to add. When finished, tap .
- To delete a group, tap  to select a group, and then tap  > **Delete**.
- To remove or move contacts, select a group, and then tap  to select the contacts you want to remove or move. When finished, tap  or  > Target group.
- To send a message to members of a group, first select a group. Tap  > **Group messaging**, select the contacts you want to send a message to, and then tap .
- To set a ringtone for a group, first select a group. Tap  > **Group ringtone**, and set your favorite sound as the ringtone.

Other features

To select the display method for contacts or view the storage location, tap  > **Contacts settings** from Contacts.

- To display the contacts with numbers only in the Contacts list, enable **Display contacts with numbers only**.
- To view or change the storage location of contacts, tap **Storage location**.

Note

If only one option is available for storage, the option cannot be edited.

- To display the contacts stored in a given location or view the number of contacts in each storage location, tap **Show contacts by account**.

Settings

Network & internet

 **Tip:** Whether the app is supported on a certain device and what features are available may vary by device model, carrier, and country/region. Please contact your distributor or service provider for more information.

● **Wi-Fi**

Connect to a Wi-Fi network

Method:

1. Enable Wi-Fi in the following ways:



- Swipe down from the top of the screen to open the Control center, and tap .
 - Go to **Settings > Network & internet**, and enable **Wi-Fi**.
2. Go to **Settings > Network & internet > Wi-Fi**, and tap a network to connect to it.

 indicates a Wi-Fi password is required.

Add a Wi-Fi network manually

To add a Wi-Fi network that doesn't appear in the list of available networks, go to **Settings > Network & internet > Wi-Fi** and add a Wi-Fi network by using the following method:

Method:

- Tap  **Add network**, and enter the SSID and security key.
- Tap  to scan the Wi-Fi QR code.

● SIM card & mobile network

From **SIM card & mobile network**, you can learn about the current SIM card status of your device, edit SIM card information, and more.

Enable mobile data

Method:

- Swipe down from the top of the screen to open the Control center, and tap .
- Go to **Settings > Network & internet > SIM card & mobile network**, and enable **Mobile data**.

Edit SIM card information

Method:

1. Go to **Settings > Network & internet > SIM card & mobile network**, and tap the SIM card you want to edit under **SIM card info & settings**.
2. Do any of the following:
 - To change the SIM card name or number, tap **SIM name** or **Number**.
 - To check the data usage in a certain period of time, go to **App data usage**.
 - To set the preferred network type for your SIM card, tap **Preferred network type** (available in some countries).

● Airplane mode

You must enable Airplane mode on your phone while flying in an airplane.

Enable Airplane mode in the following ways:

- Swipe down from the top of the screen to open the Control center, and tap .
- Go to **Settings > Network & internet**, and enable **Airplane mode**.

● Hotspot & tethering

Hotspot & tethering allows you to create a hotspot that can be used by other devices through Wi-Fi, Bluetooth, USB, and Ethernet.

Tether by Wi-Fi

Method:

1. Enable Wi-Fi hotspot in the following ways:

- Swipe down from the top of the screen to open the Control center, and tap .
- Go to **Settings > Network & internet > Hotspot & tethering > Wi-Fi hotspot** to enable the feature.

2. To change your hotspot name or password, tap the corresponding options.

Tether by Bluetooth or USB cable

Method:

1. Go to **Settings > Network & internet > Hotspot & tethering** to enable **Tether by USB cable** or **Tether by Bluetooth**.
2. Do any of the following:
 - To tether by USB cable, connect your phone to the other device with a USB cable.
 - To tether by Bluetooth, pair your phone with the other device.

Note

Mac computers can't tether with Android devices by USB.

● Network management

You can control whether to allow your apps to access mobile network or Wi-Fi.

Method:

1. Go to **Settings > Network & internet > Network management > Mobile network or Wi-Fi**.
2. Tap  to enable or  to disable network management.

● Data Saver

Method:

1. Go to **Settings > Network & internet > Data Saver** to enable Data Saver.
2. To prevent Data Saver from affecting certain apps, go to **Unrestricted data** and toggle on the option.

● VPN

VPN allows you to connect to a private secured network from your device.

Method:

1. Tap **Settings > Network & internet > VPN > +**, and enter and save the required information.
2. Select a configured VPN and enter your username and password.

● Private DNS

A private DNS can protect your privacy and security while connecting to a target URL.

Method:

1. Go to **Settings > Network & internet > Private DNS**.
2. Select a DNS and save it.

Bluetooth & devices

 **Tip: Whether the app is supported on a certain device and what features are available may vary by device model, carrier, and country/region. Please contact your distributor or service provider for more information.**

● Bluetooth

You can use **Bluetooth** to connect your device to nearby devices or to transfer files between devices.

Enable Bluetooth

To enable Bluetooth:

- Swipe down from the top of the screen to open the Control center, and tap .
- Go to **Settings** > **Bluetooth & devices**, and enable **Bluetooth**.

Rename your device

Method:

1. Enable Bluetooth and go to **Settings** > **Bluetooth & devices** > **Bluetooth** > **Device name**.
2. Enter a device name.
3. Tap **Rename**.

Pair other Bluetooth devices

Method:

1. Go to **Settings** > **Bluetooth & devices** > **Bluetooth** > **Pair new device**.
2. Select a device to pair with.
3. Tap **Pair**.

Note

To use this feature, make sure the other device has Bluetooth enabled and accepts the incoming pairing request.

Send and receive files

You can share data with other Bluetooth devices in the following way.

For example, to send photos to another device:

1. Open **Albums** and select photos to send.
2. Tap **Share** > **Bluetooth**.
3. Select a device to receive the photos.

Note

To use this feature, make sure the other device has Bluetooth enabled and accepts the incoming connection request.

View the files received via Bluetooth

To view the files received via Bluetooth, go to **Settings** > **Bluetooth & devices** > **Bluetooth** > **Files received via Bluetooth**, and view them.

● Smart Mirroring

With Smart Mirroring, you can cast the content from your device to another device over Wi-Fi using the following methods.

Method 1:

Go to **Settings** > **Bluetooth & devices** > **Smart Mirroring**.

Method 2:

1. Swipe down from the top of the screen to open the Control center, and swipe down again to expand the shortcuts panel.
2. Tap .

Note

You must connect your device to the internet to use this feature.

Connect to a mirroring device

Method:

1. Tap **Connect to mirroring device**.

2. From the search results, tap the device you want to cast your screen to.

Note

1. Make sure your device is on the same Wi-Fi network as the mirroring device during mirroring.
2. Make sure the mirroring device can be connected to Wi-Fi and uses the DLNA protocol.

● **OTG**

OTG allows you to connect a USB storage device to your device, and then browse and manage the images, videos, and other files stored on the USB storage device by going to File Manager on your device.

Note

If idle for five minutes, OTG will be automatically disabled.

● **Printing**

To print photos or files from certain apps on your device, enable **Default print service**.

Add and use a printer

· To add a print service:

1. Go to **Settings > Bluetooth & devices > Printing**.
2. Tap **+**.
3. Enter printer information.

· To use a print service:

1. Go to **Settings > Bluetooth & devices > Printing**.
2. Tap the printer service.

Note

1. Add a printer that can exchange data via the internet before printing.
2. Sign in to your Google account before using this feature.

● **Chromebook**

You can do any of the following once your phone is connected to a Chromebook:

- Sync chat history.
- Share files.
- Use the Chromebook to send and receive SMS messages.
- Connect the Chromebook to your device's network.
- Use your device to unlock the Chromebook.

Note

Sign in to your Google account before using this feature.

● **Nearby Share**

To share photos, videos, documents, and other files with nearby devices, go to **Settings > Bluetooth & devices > Nearby Share**. You can then do any of the following:

- To enable this feature, swipe down from the top of the screen to open the Control center, and tap .
- To rename your device, tap **Device name**, enter a name, and then tap **Rename**.
- To choose who can share content with you, go to **Device visibility** and select an option as needed.
- To get notified when someone shares content with you, turn on **Show notification**.
- To learn more about these options, go to **Learn more**.

Note

Before using this feature, turn on Bluetooth and Location first.

● Android Auto

To connect your phone to your car display via a USB data cable or over Wi-Fi to get directions, make or answer calls, talk to send SMS messages, and play music, go to **Settings** > **Bluetooth & devices** > **Android Auto**.

Note

To get detailed guidance, tap  > **Help & feedback** on the **Android Auto** screen.

Display & brightness



 **Tip: Whether the app is supported on a certain device and what features are available may vary by device model, carrier, and country/region. Please contact your distributor or service provider for more information.**

With this option, you can change or adjust the display settings for your device, such as screen brightness and fonts.

Adjust the screen brightness

• Manually adjust the screen brightness

You can adjust it by using the following method:

- Swipe down from the top of the screen to open the Control center, and drag .
- Go to **Settings** > **Display & brightness**, and drag .

• Automatically adjust the screen brightness

You can adjust it by using the following method:

- Swipe down from the top of the screen to open the Control center, and tap .
- Go to **Settings** > **Display & brightness**, and tap **Adaptive brightness**.

Enable Eye Protection

Eye Protection displays warmer colors on your screen that are easier on your eyes.

To enable Eye Protection:

- Swipe down from the top of the screen to open the Control center, swipe down again to expand the shortcuts panel, and then tap .
- Go to **Settings** > **Display & brightness** > **Eye Protection** to enable the feature.

• Schedule Eye Protection on/off

Method:

1. Go to **Settings** > **Display & brightness** > **Eye Protection**, and tap **Schedule**.
2. Do any of the following:
 - Select **Sunset to sunrise**.
 - Select **Turn on at custom time** to set the start time and end time.

Enable Dark theme

On some screens, Dark theme will use a solid black background which will help extend your battery life.

To enable Dark theme:

- Swipe down from the top of the screen to open the Control center, swipe down again to expand the shortcuts panel, and then tap .
- Go to **Settings > Display & brightness > Dark theme** to enable the feature.

• Schedule Dark theme on/off

Method:

1. Go to **Settings > Display & brightness > Dark theme**.
2. Do any of the following:
 - Tap **Sunset to sunrise**.
 - Tap **Turn on at custom time** to set the start time and end time.

Set up auto-lock

This feature automatically locks your screen after a certain period of inactivity.



Method:

1. Go to **Settings > Display & brightness** and tap **Screen timeout**.
2. Select a period.

Adjust the font size and style

• Adjust fonts:

Method:

1. Go to **Settings > Display & brightness > Font & display size**.
2. Do any of the following:
 - To enlarge or reduce the font size, drag  under **Font size**.
 - To enlarge or reduce the size of displayed content, drag  under **Display size**.
 - To make all fonts appear with bold weight, tap **Bold font**.

• Change the font style

Method:

1. Go to **Settings > Display & brightness > Font style**.
2. Do any of the following:
 - Select a preloaded style.
 - Tap **Download more** to download a preferred style.

Note

1. Some options may not be available or vary depending on your country/region and device model.
2. If you can't find a certain option on your device, it means the feature is not supported.

Adjust the status bar

Method:

1. Go to **Settings > Display & brightness > Status bar**.
2. Do any of the following:
 - To display notifications with icons or numbers on the status bar, tap **Notification method** to select one of the available options.
 - To display the real-time network speed on the status bar, enable **Display real-time network speed**.
 - To change battery style or set power display, go to **Battery pattern and power percentage**.

Enable screen saver

Method:

1. Go to **Settings > Display & brightness > Screen saver.**
2. Enable **Use screen saver.**
3. Select a screen saver style and start time.

Adjust the screen refresh rate

Method:

1. Go to **Settings > Display & brightness > Screen refresh rate.**
2. Select a refresh rate.

Customize the app aspect ratio

• Display apps in full screen

Most apps installed on your device will automatically adapt to display correctly in full screen mode. For apps that don't automatically adapt, do the following:

Method:

1. Go to **Settings > Display & brightness > Full screen display of apps.**
2. Turn on switches of the apps.

• Display apps at the top of the screen

Method:

1. Go to **Settings > Display & brightness > Display at the top of the screen.**
2. Go to an app that you want to edit.
3. Select a display effect.

Lock screen & wallpaper

 **Tip: Whether the app is supported on a certain device and what features are available may vary by device model, carrier, and country/region. Please contact your distributor or service provider for more information.**

Customize Always On Display

Always On Display allows you to check the time and date, battery level, and notifications when picking up your phone or within a certain period of time.

Method:

1. Go to **Settings > Lock screen & wallpaper > Always On Display**, and enable **Always On Display.**
2. Do any of the following:
 - To change the Always On Display style, go to **Always On Display styles** to select your preferred style, and then tap **Apply.**
 - To change how to show Always On Display, tap **Display mode** to pick an option.

Customize the theme or wallpaper

This option allows you to set up the theme or wallpaper for your device.

Method:

1. Go to **Settings > Lock screen & wallpaper > Theme or Wallpaper.**
2. Select a theme or wallpaper.

Change UI colors

The option allows you to change the UI color for your device.

Method:

1. Go to **Settings > Lock screen & wallpaper > Color and style** and enable **System and app screen color change**.
2. Select an embedded color or select a color from Wallpaper.
3. To restore the default color of the system and apps, disable **System and app screen color change**.

Lock screen settings

This option allows you to change the lock screen style and customize lock screen shortcuts.

Method:

1. Go to **Settings > Lock screen & wallpaper > Lock screen settings**.
2. Do any of the following:
 - To set the lock screen clock, date style, or features that can be quickly started on the locked screen, go to **Custom lock screen**
 - To change the lock screen wallpaper with the theme, enable **Change lock screen wallpaper based on theme**.

Note

Only static wallpapers can change along with themes.

- To open the Control center from the lock screen, enable **Open Control center from the lock screen**.

Home settings

This option allows you to change the home screen style, layout, badges, and other settings.

Method:

1. Go to **Settings > Lock screen & wallpaper > Home settings**.
2. Do any of the following:
 - To change the home screen style, go to **Home screen style** to select between Standard and Drawer.
 - To add the icons of newly downloaded apps to the home screen, enable **Add icons to home screen**.
 - To change the home screen layout, go to **Home screen layouts** to select between 4x6 and 5x6.
 - To lock the current home screen layout, enable **Lock layout**.
 - To change the feature that is enabled when swiping down on the home screen, tap **Swipe down on home screen** to pick an option.

Note

1. Some options may not be available or may vary depending on your country/region and device model.
2. If you can't find a certain option on your device, it means the feature is not supported.

Simple Mode

To enable a streamlined home screen and larger system font, go to **Settings > Lock screen & wallpaper > Simple Mode** to enable the feature.

Dynamic effects

 **Tip: Whether the app is supported on a certain device and what features are available may vary by device model, carrier, and country/region. Please contact your distributor or service provider for more information.**

A variety of animation styles are provided under the corresponding feature. You can go to **Settings > Dynamic effects** to select and apply your favorite style.

Enhance the dynamic effects of some interfaces

To enhance the dynamic effects and display effects of some interfaces, go to **Settings > Dynamic effects > Enhance dynamic effects**, and enable **Interface dynamic effects**.

Change the touch screen animation

To change the touch screen animation:

1. Tap **Touch screen animation**.
2. Select an animation that you prefer.
3. Drag  left and right to adjust the number of displayed particles.
4. Tap **Apply**.

Show ambient light effect

To display the ambient light effect when the screen is on or off, go to **Ambient light effect** and enable **Always On Display** or **On-screen display**.

Change the home screen animation

To change the home screen animation, go to **Home screen transition animation** or **Unlock to enter home screen animation** to select your preferred animation, and then tap **Apply**.

Change the fingerprint or face recognition animation

To change the fingerprint or face recognition animation:

1. Tap **Fingerprint icon animation**, **Fingerprint recognition animation**, or **Face recognition animation**.
2. Select your preferred animation.
3. Tap **Apply**.

Note

1. This feature is available only on devices that support fingerprint or face recognition.
2. When the fingerprint or face recognition is disabled on your device, you need to select a screen lock option after applying the animation, and then follow the on-screen instructions for the subsequent steps.

Change the USB insertion or charging animation

To change the USB insertion or charging animation, go to **Charging animation** or **USB insertion animation** to select your preferred animation, and then tap **Apply**.

Note

This feature is available only on devices that support fast charging.

Change the screen on/off animation

To change the screen on/off animation when pressing the Power button, go to **Screen on/off animation** to select your preferred animation, and then tap **Apply**.

Note

This feature is not available when face recognition or fast charging is used.

Sounds & vibration

 **Tip: Whether the app is supported on a certain device and what features are available may vary by device model, carrier, and country/region. Please contact your distributor or service provider for more information.**

To change the media sound, ringtone, or the sounds your device plays when you get other types of notifications, go to **Settings > Sounds & vibration**.

Adjust the function of the volume buttons

To change whether the volume buttons adjust the media or ringtone volume, tap **Use volume buttons to adjust**.

Vibrate for incoming calls and notifications

To change the vibration mode or intensity for incoming calls or notifications, go to **Vibrate for incoming calls** or **Vibrate for notifications**.

Enable Do Not Disturb

To receive notifications from important contacts and apps only, enable **Do Not Disturb**.

Enable Do Not Disturb in the following ways:

- Swipe down from the top of the screen to open the Control center, swipe down again to expand the shortcuts panel, and then tap .
- Go to **Settings > Sounds & vibration > Do Not Disturb**, and enable **Do Not Disturb**.

Customize ringtone

To change the ringtone settings, go to **Settings > Sounds & vibration > Phone ringtone, Notification ringtone, Alarm ringtone, or Message ringtone** (available in some countries).

You can choose either a system ringtone or a custom ringtone based on your preference.

Customize other sounds and vibration

- To play a sound when dialing numbers on the keypad, enable **Dial pad tones**.
- To play a sound when locking your screen, enable **Screen lock sound**.
- To play a sound and turn on vibration when a charger is connected, enable **Charging sounds & vibration**.
- To play a sound when touching your screen, enable **Touch sound**.
- To play a sound when taking a screenshot, enable **Screen capture tone**.
- To play haptic feedback for tap, keyboard, and more, enable **Touch vibration**.
- To turn on vibration when your call is answered or hung up, enable **Vibrates when the other party answers/hangs up** (available in some countries).
- To change the emergency tone, go to **Settings > Sounds & vibration > Emergency tone** (available in some countries).

Change sound quality and effects

To change the sound quality or effects, go to **Settings > Sounds & vibration > Sound quality & effects**.

Apps

View screen time

- **Get a daily view of how long you use apps, how many notifications you receive, and how often you check your device**

Method:

1. Go to **Settings > Apps > Screen time**.

2. Do any of the following:

· Tap  to switch between **Screen time**, **Notifications received**, or **Times opened/Unlocks** to view details.

· Tap  or  to switch to different dates.

- **Set app timers**

To limit how much time you spend on an app:

Method:

1. Go to **Settings > Apps > Screen time**.

2. Tap  next to an app.

3. Set use time of the app and tap **OK**.

Note

1. When you run out of time, the app closes and its icon dims.
2. App timers reset at midnight.

Set as the default app

When you have multiple apps that serve the same purpose, you can choose one as the default app.

Method:

1. Go to **Settings > Apps > Default apps**.

2. Tap the app you want to change.

3. Select the app you want to use by default.

View unused apps

To view the list of apps that haven't been used recently, go to **Settings > Apps > Unused apps**.

Grant special access to apps

To grant other special access (such as Autostart and Do Not Disturb) to the apps, go to **Settings > Apps > Special app access** for detailed settings.

Notifications

Manage app notifications

- **Enable or disable app notifications**

To check the apps from which you have received notifications or the number of notifications you have recently received:

Method 1:

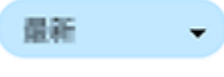
1. Go to **Settings > Notifications > App settings**, and tap  to filter apps by different criteria.
2. Turn on or off the app notification switch.

Method 2:

1. Swipe down from the top of the screen to open the Control center.
2. Do any of the following:
 - Tap and hold the notification you want to clear, and tap **Clear notification**.
 - Tap and hold the notification you want to clear, and tap  to toggle on or off the corresponding options.

• **Set up other notifications**

To view notifications, control which apps can read notifications, and more:

Method:

- To view recent and snoozed notifications, go to **Settings > Notifications > Notification history** to enable **Use notification history**.
- To control which devices and apps can read notifications, go to **Settings > Notifications > Devices & app notifications** and tap any option for detailed settings.

Manage app conversations

• **View priority conversations or edited conversations**

To view the flagged priority conversations and edited conversations, go to **Settings > Notifications > Conversations**.

• **Enable Bubbles**

To display some conversations as floating icons on top of other apps, go to **Settings > Notifications > Bubbles** and enable **Allow apps to show bubbles**.

Manage how notifications are displayed on the lock screen

To manage how notifications are displayed on the lock screen:

Method:

1. Go to **Settings > Notifications** and tap **Lock screen notifications**.
2. Select from the following options as needed:
 - To display all notifications on the lock screen, select **Show default and muted conversations**.
 - To hide muted conversations and notifications on the lock screen, select **Hide muted conversations and notifications**.
 - To block notifications on the lock screen, select **Don't show any notifications**.

Set up other general notifications

To set up the notification sound, snoozed notifications, and app icon badges, go to **Settings > Notifications** to set them in detail as needed.

Battery

To check your battery usage and power consumption over time, go to **Settings > Battery**.

Manage the power consumption of background apps

To get a daily view of the power consumption of each background app, go to **Background power consumption management**.

View battery percentage

To display the battery percentage in the status bar, enable **Battery pattern and power percentage**.

Usage since last full charge

To view the battery usage since the last full charge or power consumption by the system and apps, go to **Usage since last full charge**.

Note

The power consumption is approximate and may vary depending on usage.

RAM & storage space

To check the usage of RAM and storage space on your device, go to **RAM & storage space**.

Manage storage space

Method:

1. Go to **Settings > RAM & storage space > Manage storage**.
2. Select the files you want to remove and tap **Clean**.

Note

You must connect your device to the internet to use this feature.

Security

 **Tip: Whether the app is supported on a certain device and what features are available may vary by device model, carrier, and country/region. Please contact your distributor or service provider for more information.**

This feature allows you to update your security status, as well as set a screen lock, fingerprint lock, or face lock.

Use Google Play Protect to scan your device

Google Play Protect checks your device and apps on a regular basis for harmful behaviors, and notifies you of any security risks.

• **Scan apps manually with Google Play Protect**

Method:

1. Go to **Settings > Security > Google Play Protect**.
2. Tap **Scan**.

• Enable or disable Google Play Protect

Method:

1. Go to **Settings > Security > Google Play Protect**.
2. Tap .
3. Enable or disable the corresponding button.

Note

You must connect your device to the internet to use this feature.

Find My Device

To remotely locate, find, lock, or erase your device, make sure your device:

- Is powered on.
- Has **Find My Device** enabled.
- Is signed in to your Google account.
- Is connected to a network.
- Has Location enabled.
- Is visible on Google Play.

• Remotely locate, find, lock, or erase your device

Method:

1. Go to **Settings > Security > Find My Device**, tap the '**Find My Device**' **website** or go to Google to find the website of the device, and sign in to the Google account.
2. The lost device receives a notice.
3. Obtain the approximate or last position of the lost device.
4. Select an operation to perform.

Note

1. To learn more about other options, go to **Settings > Security > Find My Device > Learn more**.
2. You must connect your device to the internet to use this feature.

Set a screen lock, fingerprint lock, or face lock on your device

If you have set up a screen lock, fingerprint lock, or face lock to help secure your device, each time you turn on your device or wake up the screen, you will be asked to unlock your device.

• Set a screen lock

To set a screen lock:

1. Go to **Settings > Security > Screen lock**.
2. Select a password type:
 - By choosing **Pattern**, you need to draw an unlock pattern.
 - By choosing **PIN**, you need to enter a numeric password.
 - By choosing **Complex password**, you need to enter a complex alphanumeric password.
3. Set the notice display method in screen lock mode.
4. To cancel the screen lock you have set up, select **None** or **Swipe**.

• Set a fingerprint lock

To set a fingerprint lock:

1. Go to **Settings > Security > Fingerprint**.
2. Select a standby screen lock method.
 - By choosing a combination of **Fingerprint and Pattern**, you need to draw an unlock pattern.
 - By choosing a combination of **Fingerprint and PIN**, you need to enter a numeric password.
 - By choosing a combination of **Fingerprint and Complex password**, you need to enter a complex alphanumeric password.
3. Set the notice display method in screen lock mode.
4. Tap **Start enrollment** and follow the screen prompt to complete fingerprint enrollment.

5. To remove a registered fingerprint, go to **Settings > Security > Fingerprint** and tap  next to the fingerprint you want to remove.

• **Set a face lock**

To set a face lock:

1. Go to **Settings > Security > Face**.

2. Select a standby screen lock method.

· By choosing **Face+Pattern**, you need to draw an unlock pattern.

· By choosing **Face+PIN**, you need to enter a numeric password.

· By choosing **Face+Complex password**, you need to enter a complex alphanumeric password.

3. Set the notice display method in screen lock mode.

4. Follow the screen prompt to complete face enrollment.

5. Do any of the following:

· To clear the registered face data, go to **Settings > Security > Face** and tap **Clear face data**.

· To enable your device to directly access the home screen after face unlock, go to **Settings > Security > Face**, and disable **Stay on lock screen after unlocking**.

Keep your device unlocked

With this feature, you can keep your device unlocked while it is in a trusted location or connected to another device.

Method:

1. Go to **Settings > Security > Extend Unlock**.

2. Enter the password or draw the pattern to unlock the screen.

3. Go to the corresponding option to enable it.

Note

Before using this feature, set a screen lock first.

Set a privacy password for your device to encrypt or hide your apps

To set a privacy password for your device to encrypt or hide your apps:

Method:

1. Go to **Settings > Security > Privacy & app encryption**.

2. Tap **Password** to select a password type and set a password.

3. Follow the screen prompt to set security questions.

4. Do any of the following:

· To encrypt your apps with the privacy password, go to **App encryption** and toggle on the options as needed.

· To hide your apps with the privacy password, go to **App hiding** and toggle on the options as needed.

• **View hidden apps**

Method:

· Go to **Settings > Security > Privacy & app encryption > View hidden apps**.

· Go to **Settings > Security > Privacy & app encryption > App hiding**, enable **View hidden apps**, and then swipe up with two fingers on the home screen.

Privacy

To configure additional settings for privacy and security-related features, go to **Settings > Privacy**.

Overview of features

- **Permission manager:** View the apps that are allowed or denied access to permissions such as Location and Phone. You can change the app permissions as needed.
- **Show passwords:** View your passwords as you enter them.
- **Notifications on lock screen:** Configure how notifications are displayed on the lock screen.
- **Recent apps preview:** Enable or disable blur preview of specified apps as needed when **Blur display of recent apps** is enabled.
- **Screen capture protection:** Prevent third-party apps from taking screenshots or recording the screen when you enter passwords so as not to disclose them.
- **Alert when clipboard is accessed:** Get an alert when an app accesses text, images, or other content you have copied.
- **Unlock to power off:** Unlock your device to power it off or restart it.

Note

Unlock to power off is available only when you have set a lock screen password for your device.

Location

You can use location-based services to view the commute predictions and nearby restaurants once **Location** is enabled.

Turn on Location

To turn on Location:

- Swipe down from the top of the screen to open the Control center, swipe down again to expand the shortcuts panel, and then tap .
- Go to **Settings > Location** and tap **Use location**.

Find or choose which apps use your phone's location

Method:

1. Enable Location and go to **Settings > Location > View all**.
2. Do any of the following:
 - View the apps that have recently accessed location information.
 - To change an app's permissions, tap the app and then choose the location access.

Note



You may need to sign in to your Google account to use some of the features.

Ultra Game Mode

Ultra Game Mode allows you to immerse yourself in games by fully enhancing the performance of your device.

Add games to Ultra Game Mode

Method:

1. Go to **Settings > Ultra Game Mode**.
2. Do any of the following:
 - If you haven't added any games to Ultra Game Mode, tap **Add**.
 - If you have added games to Ultra Game Mode, tap  > .

Enable game modes

• Enable Esports Mode

Method:

1. Go to **Settings > Ultra Game Mode** and enable **Game sidebar**.
2. Access a game that has been added to Ultra Game Mode, and swipe inward from the left edge of your screen in the upper part to bring out the game sidebar.
3. Tap  **Esports Mode**.

• Enable Off-screen autoplay

Method:

1. Go to **Settings > Ultra Game Mode** and enable **Game sidebar**.
2. Access a game that has been added to Ultra Game Mode, and swipe inward from the left edge of your screen in the upper part to bring out the game sidebar.
3. Tap  **Off-screen Autoplay**.

Do Not Disturb during gameplay

To hide notifications or prevent accidental touch of the screen during gameplay:

Method:

1. Go to **Settings > Ultra Game Mode**.
2. Do any of the following:
 - To hide the floating notifications from the top of the screen during gameplay, enable **Block notifications**.
 - To reject incoming calls or make them run in the background during gameplay, go to **Mute call notifications** to enable **Background calls** or **Reject calls** (available in some countries).
 - To prevent accidental touch of the screen during gameplay, go to **Accidental touch prevention** and toggle on the options as needed.

Note

1. Whether the app is supported on a certain device and what features are available may vary by device model, carrier, and country/region.
2. If you can't find a certain option on your device, it means the feature is not supported.

Shortcuts & accessibility

 **Tip: Whether the app is supported on a certain device and what features are available may vary by device model, carrier, and country/region. Please contact your distributor or service provider for more information.**

● S-capture

Enable screenshot preview

To bring up a floating window for operations such as sharing and editing after taking a screenshot, enable **Screenshot floating window**.

Note

The feature is not supported in Super Battery Saver mode, Kids Mode, Setup Wizard, or on the lock screen.

Record the screen

- To display the touch or tap trajectory during screen recording, enable **Display touch trajectory**.
- To record ambient sounds or system playback sounds during screen recording, go to **Record sound** to select any of the sound types.
- To change the picture quality during screen recording, go to **Picture quality** to select a desired effect.
- To avoid being disturbed by floating notifications during screen recording, enable **DND recording**.
- To automatically select a dynamic area on the screen as the initial area for animation recording during screen recording, enable **Auto select dynamic area**.

● **Split screen**

Enable split-screen mode

Enable split-screen for apps that support this mode in the following ways:

Method 1:

1. Access the Recent apps screen.
2. Tap  >  **Split-screen**.

Method 2:

If you have enabled the Swipe up with three fingers to split screen feature, split the screen by sliding up with three fingers.

To enable the Swipe up with three fingers to split screen feature, go to **Settings > Shortcuts & accessibility > Split screen** and enable **Swipe up with three fingers to split screen**.

Method 3:

1. Swipe down from the top of the screen to open the Control center, and swipe down again to expand the shortcuts panel.
2. Tap .

Enable message screen-split

Method:

1. Go to **Settings > Shortcuts & accessibility > Screen split**, and enable **Message screen-split**.
2. Select the apps from which notifications will be displayed as floating messages.

● **Small window**

To display apps in a small window, go to **Small window > Learn gestures** to view and perform operations such as displaying or hiding apps in the small window.

● **Smart sidebar**

Enable this feature to quickly access apps on any screen.

Enable Smart sidebar

1. Go to **Settings > Shortcuts & accessibility > Smart sidebar**.
2. Enable **Smart sidebar**.
3. To expand the smart sidebar, tap and hold the indication bar and slide inwards on the screen.

Change the display style of the indication bar

Default styles:

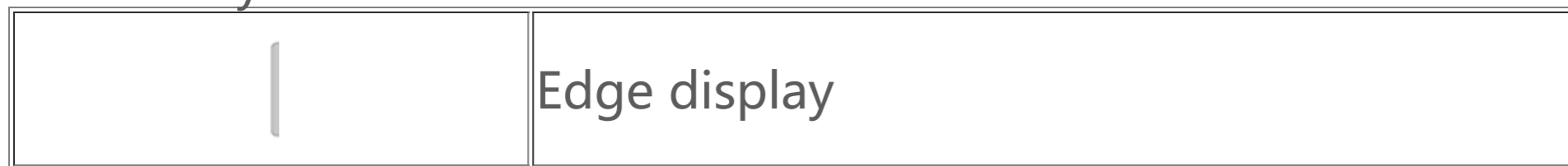







· To change the visibility of the indication bar when it is idle, drag  under **Opacity of indicator bar when idle**.

Manage the apps in the smart sidebar

· To manage the apps integrated in the smart sidebar, do the following:

Method:

1. Tap and hold the indication bar and slide inwards on the screen to expand the smart sidebar.
2. Tap   .
3. Tap  to add or tap  to delete the apps.
4. After the operation, tap .

● Smart Motion

Enable Smart Motion to use some features intelligently or quickly.

Note

1. Whether the app is supported on a certain device and what features are available may vary by device model, carrier, and country/region.
2. If you can't find a certain option on your device, it means the feature is not supported.

Enable Smart Screen On/Off

To enable Smart Screen On/Off in a smart way:

Method:

1. Go to **Settings > Shortcuts & accessibility > Smart Motion > Smart Screen On/Off**.
2. Do any of the following:
 - To turn on the screen automatically by lifting your device, enable **Raise to wake**.
 - To turn on the screen by double-tapping it, enable **Double-tap to wake**.
 - To turn off the screen by double-tapping it, enable **Double-tap to turn off**.

Turn on the flashlight

To quickly turn on the flashlight by shaking your device when the screen is on regardless of whether it is locked:

Method:

1. Go to **Settings > Shortcuts & accessibility > Smart Motion**.
2. Enable **Shake to turn on the flashlight**.

Enable Smart Calling

Enable Smart Calling to make it more convenient and smarter to make or answer calls.

Method:

1. Go to **Settings > Shortcuts & accessibility > Smart Motion > Smart Calling**.
2. Toggle on the corresponding option based on needs.

● Quick action

To quickly enable a feature by pressing and holding the Volume down button when the screen is off, enable **Quick action** to assign a feature to the button.

Note

The selected feature won't work during music playback or if the IR sensor is blocked.

● Press and hold the Power button

To access Google Assistant or the power and emergency menu by pressing and holding the Power button:

1. Go to **Settings > Shortcuts & accessibility > Press & hold Power button**.
2. Tap **Press & hold Power button**.
3. Select the corresponding features to enable.

● Easy Touch



Enable Easy Touch to quickly access frequently used tools or apps on the home screen.

Enable Easy Touch

1. Go to **Settings > Shortcuts & accessibility > Easy Touch**.
2. Enable **Easy Touch**.

Change the display styles of Easy Touch

Default styles:

	Floating
	Edge display

· To change the style of Easy Touch:

1. Tap **Personalized skins**.
2. Select a skin pattern.
3. Tap **Apply**.

· To change the visibility of Easy Touch when it is idle, drag  under **Idle visibility**.

More settings of Easy Touch

· To customize the quick tools or apps on the Easy Touch menu:

1. Tap **Customize menu**.

2. Tap **+** to add apps or quick tools.

To reposition an app or tool, tap and hold its icon and drag it to a desired position.

· To access a certain quick tool when you tap, double-tap, or tap and hold Easy Touch:

1. Tap **Tap, Double tap, or Tap and hold**.
2. Select a required tool.

● Face beauty for video call

To apply beauty effects during a video call, go to **Settings > Shortcuts & accessibility > Face beauty for video call**, and select the apps you want to enable this feature for.

● Flash notifications





To get rear flash alerts of incoming calls and messages when the screen is off, go to **Settings > Shortcuts & accessibility > Flash notifications** to toggle the **Incoming calls** or **Messages** option on (this feature is available in some countries).

● Task timer

· To schedule auto power on or off for your device, go to **Settings > Shortcuts & accessibility > Task timer**, and then tap Scheduled power on/off to set time points.

· To schedule vibration or airplane mode on your device, go to **Settings > Shortcuts & accessibility > Task timer** to toggle the options on.

To configure the settings for these modes:

1. Tap time in a mode to access the settings screen.
2. In the pop-up box, tap  or  to switch the mode for the set time.
 - : Slide the hands to the hour and minute you want.
 - : Enter the hour and minute you want.
3. Tap **OK**.
4. Tap **Repeat** to select the days on which you want the event to repeat, and tap **Done**.
5. Tap .

Note

When it is time for the scheduled power-off, you will be prompted to confirm it. You can also cancel the power-off by tapping **Cancel**. If you neither confirm nor cancel the power-off, your device will turn off in 60 seconds.

● **One-handed**

Navigate your device with one hand in the following ways:



Bring up the mini screen

Method:

1. Go to **Settings > Shortcuts & accessibility > One-handed**.
2. Enable **Access mini screen using gesture**.
3. Slide inward from the edge of your screen and slide back to the edge of the screen.

Resize the mini screen

Method:

1. On the mini screen, tap .
2. Resize the mini screen in the following ways:
 - Pinch in or out on the mini screen.
 - Drag .

● **Accessibility**

Accessibility features, such as screen reader apps and magnification, make it easier for you to navigate your device.

Note

1. Whether the app is supported on a certain device and what features are available may vary by device model, carrier, and country/region.
2. If you can't find a certain option on your device, it means the feature is not supported.

Enable or disable TalkBack

You can hear the text you have touched or selected with the help of TalkBack.

To enable or disable TalkBack:

- Go to **Settings > Shortcuts & accessibility > Accessibility > TalkBack**, and toggle on or off **Use TalkBack**.
 - Press and hold the Volume up and down buttons for a few seconds to quickly enable TalkBack.
- To create a shortcut for TalkBack, go to **Settings > Shortcuts & accessibility > Accessibility > TalkBack**, and toggle on **TalkBack shortcut**.

Note

To get detailed guidance, tap **Settings > Tutorial & help** on the **TalkBack** screen.

Enable or disable Switch access

Switch access allows you to select items, enter text, and more using switches instead of the touchscreen.

To enable or disable Switch access:

Go to **Settings > Shortcuts & accessibility > Accessibility > Switch access**, and toggle on or off **Use Switch access**.

Note

To get detailed guidance, tap **Settings > Help & feedback** on the **Accessibility menu** screen.

Enable or disable Accessibility menu

Accessibility menu is a large on-screen menu that allows you to navigate your device with ease, such as using it to take screenshots, turn up or down the volume, and adjust the screen brightness.

To enable or disable Accessibility menu:

Go to **Settings > Shortcuts & accessibility > Accessibility > Accessibility Menu shortcut**, and toggle on or off **Accessibility Menu shortcut**.

Note

To get detailed guidance, tap **Settings > Help & feedback** on the **Accessibility Menu shortcut** screen.

Enable or disable Select to speak

You can select items on your screen or point your camera at pictures or text, and hear them to be read or described with Select to speak.

To enable or disable Select to speak:

Go to **Settings > Shortcuts & accessibility > Accessibility > Select to Speak**, and toggle on or off **Select to Speak shortcut**.

Note

To get detailed guidance, tap **Settings > Help & feedback** on the **Select to Speak** screen.

Change the display settings

- To change the screen font and the display size, go to **Accessibility > Fonts & display size** and drag .
- To correct or invert the screen color, reduce screen animations, and enlarge the mouse pointer, go to **Accessibility > Colors & animations** to toggle on or off the corresponding options.
- To dim your screen beyond the minimum brightness, go to **Accessibility > Extra dim** to enable this feature.
- To magnify the content on your screen, go to **Accessibility > Magnification** to enable this feature.

Set the caption size and style

To customize the caption size and style for easy reading:

Method:

1. Go to **Accessibility > Caption preferences**, and toggle on **Show captions**.
2. Tap **Caption size and style** to configure the settings based on your preferences.

Note

Your preferences may not work with media apps that don't support Caption preferences.

Use accessibility shortcuts

You can quickly enable an accessibility feature with a floating button from Accessibility.

Method:

1. Tap **Accessibility** to enable accessibility features, such as TalkBack.
2. Tap the floating button to support the accessibility features.
3. To change the position, size, and transparency of the floating button, go to **Accessibility > Accessibility shortcuts > Accessibility buttons**.

Digital wellbeing & parental controls

To get information about how you spend time on your phone or supervise your children's digital life, go to **Settings > Digital Wellbeing & parental controls**. Your phone use for the day will be displayed in a chart.

Manage your time in apps

• Find out how much time you spend on apps

For more information, tap the chart. For example:

- Screen time: What apps you have used and for how long.
- Unlocks: How often you have unlocked your phone and opened certain apps.
- Notifications: How many notifications you have received and from which apps.

• Limit how much time you spend on an app each day

1. Tap the chart.
2. Next to the app you want to limit, tap .
3. Choose how much time you can spend on that app and then tap **OK**.

Note

1. App timers don't work for some system apps.
2. App timers reset at midnight.

Parental controls

To set content filters or other limits on your child's device, go to **Set up parental controls**.

Google

You can use Google services on your device, such as setting up Google apps, backing up data, or finding your devices.

Method:

1. Go to **Settings > Google**.
2. Sign in to your Google account.
3. Tap to access the services you want to use.

Tap  on the home screen to learn about detailed solutions to some issues.

Note

You must connect your device to the internet to use this feature.

Accounts

Add an account

Method:

1. Go to **Settings > Accounts**, and tap .
2. Select the type of the account you want to add:
 - To directly add an account, tap **Sign in/Register with account password**.
 - To add an account through a Google account, tap **Sign in with a Google account**.
3. Follow the on-screen instructions.

• Add a Google account or other accounts

Method:

1. Go to **Settings > Accounts**, and tap **+ Add account**.
2. Select the type of the account you want to add.
3. Follow the on-screen instructions.

Remove an account

Method:

1. Go to **Settings > Accounts**.
2. Tap the account that you want to remove, and tap **Remove account/Sign out**.
3. Follow the on-screen instructions.

Note

You must connect your device to the internet to use this feature.

System

 **Tip: Whether the app is supported on a certain device and what features are available may vary by device model, carrier, and country/region. Please contact your distributor or service provider for more information.**

● System navigation

Gesture navigation

To return to the previous screen, go back to the home screen, and switch between open apps with gestures, go to **Settings > System > System navigation**, and select **Gesture navigation**.

Do any of the following as needed:

- To return to the previous screen: Swipe inward from the left or right edge of the screen.
- To go back to the home screen: Swipe up from the bottom of the screen.
- To access the Recent apps screen: Swipe up from the bottom and hold.
- To close a background app: Go to the Recent apps screen, and tap .



Note

When an app is locked, tapping  won't close it.

"3-button" navigation

To return to the previous screen, go back to the home screen, and switch between open apps with buttons, go to **Settings > System > System navigation**, and select **"3-button" navigation**.

Do any of the following as needed:

- : Return to the previous screen.
- : Go back to the home screen.
- : Access the Recent apps screen.

● Global search

Global search allows you to search for files, apps, or other content on your device as well as search for web content.

Note



1. Whether the app is supported on a certain device and what features are available may vary by device model, carrier, and country/region.
2. If you can't find a certain option on your device, it means the feature is not supported.

To use Global search:

Method:

1. Swipe on the home screen downward.
2. Enter the content you want to search for in the following ways:
 - Tap  to scan for what you want (this feature is available in some device models).
 - Enter search keywords in the search bar.

Customize search content

- To manage the content that can be searched for on your device, go to **Global search > Search content > This device**, and then tap  to select the corresponding content or  to deselect it.

● Languages & input

Change system and app language or region

To change the system language or region, go to **Settings > System > Languages & input**.

- To change the system language:
 1. Tap **Languages > +**.
 2. Select a language to add.
 3. Tap and hold and drag **=** to the top of the list.
 4. To remove a language from the list, tap **Language > ⋮ > Remove** to select the language, and then tap .

Note

To remove a language, make sure there are at least two languages in the list.

- To change the language for a certain app:
 1. Go to **App language**, and tap the app for which you want to change language.
 2. Select a language from the list.

Note

This feature is available only for apps that support language selection.

· To change to a different region:

1. Tap **Region**.
2. Enter a region that you want to replace in the search box.
3. Select a region that you want in the list.

Set up the keyboard

· To manage the input methods supported by your device, go to **On-screen keyboard** > **+**, and enable or disable any keyboard as needed.

· To display screen keyboard when connecting your device to a physical keyboard, tap **Physical keyboard** and enable **Use on-screen keyboard**.

Set up voice

· The **voice input** feature allows you to dictate commands or text with Google Assistant or Google IME.

· With **Text-to-speech output**, your device can convert text input into audio and play the audio aloud.

More tools

To check whether your spelling is correct or add words to your personal dictionary, go to **Spell checker** or **Personal dictionary**.

● **Date & time**

You can change the time, time zone, time format, and more on your device.

Automatically update or manually set the time

· To automatically update the time, enable **Set time automatically**.

Note

You must connect your device to the internet to use this feature.

· To manually set the time, tap **Date** and **Time** to change them manually.

Note

Before using this feature, disable **Set time automatically**.

Change the time zone

· To automatically update your time zone, enable **Set time zone automatically**.

Note

You must connect your device to the internet to use this feature.

· To manually change the time zone, tap **Time zone** to change it manually.

Note

Before using this feature, disable **Set time zone automatically**.

Set up the time format

- To display the time in the default locale, enable **Use locale default**.
- To display 24-hour format, enable **24-hour format**.

● Backup & restore

To back up the apps and data on your device, go to **Settings > System > Backup & restore**.

Note

You must connect your device to the internet and sign in to your account to use this feature.

● Reset options

You can use this feature to reset your device to factory settings.

- To reset your device's network settings, tap **Reset Wi-Fi, mobile & Bluetooth**.
- To reset your device's app preferences, tap **Reset app preferences**.
- To restore some features to their default settings, tap **Reset all settings**.
- To clear all data on your device and restore it to the factory settings, tap **Erase all data (factory reset)**.

Note

Back up your important data before using this feature.

● Phone clone

Tap **Phone clone** to migrate data of any kind from your old phone to a new one without consuming any data.

Assume the current phone is a new phone. The method is as follows:

On the old phone:

1. Tap  on the old phone.
2. Display the QR code.
3. Use the new phone to scan the QR code of the old phone to pair them.
4. Select files to clone.
5. Tap **Start cloning**.

On the new phone:

1. Tap  on the new phone.
2. Select the type of the old phone (iPhone or Android).
3. Scan the QR code of the old phone to pair up with the old phone.
4. Accept File transfer.

Note

1. If the old phone is an iPhone, make sure this app has been installed before transferring files.
2. When file transfer is complete, the data of the same apps on the new phone will be overwritten.

About phone

You can rename your device, and view information about your device, including software information and device status.

Method:

1. Go to **Settings > About phone**.

2. Do any of the following:

- To rename your device, tap  to enter a new name.
- To view your device model or hardware and software versions, tap **Software information**.
- To check the status of your SIM card, the cumulative power-on time, IP address, or IMEI, tap **Status**.
- To view safety information and copyright, tap **Legal information**.
- To view the Manual or service center information, or activate your E-warranty card, tap **Customer service**.

Note

You must connect your device to the internet to use some features.

Developer options

If you are an Android developer who wants to manage your device via PC, you can enable **Developer options**.

Enable Developer options

1. Go to **Settings > About phone > Software information**.
2. Tap the **Build number** option seven times.
3. Go to **Settings > System > Developer options**, and enable **USB debugging**.

Note

Enable Developer options with caution. Enabling certain settings may cause your device and apps to crash or malfunction.

System update

When updates are available, you will be prompted to download and install them.

Note

Unauthorized ROM flashing or system updates may incur security risks. You are advised to back up your data before upgrading the system.

Upgrade your device in different ways

• **Automatically detect updates**

To detect updates:

- Go to **Settings > System update**. Your device will automatically detect available updates. You can download and install them as needed.
- Go to **Settings > System update > **, and enable **Smart Upgrade**. This allows your device to automatically download and install updates via Wi-Fi during idle hours at night.

Note

1. You must connect your device to the internet to use this feature.
2. If there are no available updates, it indicates that your device is already up to date.
3. System updates may incur a large amount of data. Download them over Wi-Fi.

• Upgrade your device with an existing package

To upgrade your device with an existing package:

1. Go to **Settings > System update >  > Local upgrade**. Your device will automatically scan for available packages.
2. Select a package to install and tap **Update now**.

Note

A system update package is required on your device to use this option.

App clone

App clone allows you to create a second instance of an app so that you can use two accounts at the same time.

Method:

1. Go to **Settings > Apps > App clone**.
2. Toggle on the apps that have been installed and support app clone.
3. The cloned app will be displayed with the name of Π ·xxx on the home screen.

Note

1. Toggling off the cloned app or uninstalling the primary app will delete the cloned app and its data.
2. Concurrent apps may cause local data to increase. Clean data with iManager promptly.
3. Depending on the actual use scenarios and third-party apps, this feature is available only to those apps that require sign-in.
4. App clone can only be used on our Launcher, and may not work properly on other launchers.

Multiple users

Multiple users allows you to share your device with your family members or friends by creating individual profiles and personal spaces where they can customize a variety of features.

To enable this feature: Go to **Settings > System > Multiple users**.

Multiple user accounts

Owner: The owner of the device.

The owner can create, remove, and manage other user and guest accounts. The owner account is always running even if other user or guest accounts are running in the foreground.

User: A person who doesn't own but may often use the device, such as family members.

Each user has their own exclusive space where they can customize their own home screen, sign in to accounts, and install apps.

Guest: A person who uses the device for a short time.

Each guest has their own space on the device.

Add a user or guest account

Method:

1. Go to **Settings > System > Multiple users** and tap **On**.
2. Do any of the following:
 - To add a guest account, tap **Add guest**.
 - To add a user account, tap **Add user**, enter a username, and then tap **OK**.

Note

The user or guest accounts can only be added by the device owner.

Switch between the owner, user, and guest accounts

To switch between the owner, user, and guest accounts:

Method 1:

1. Go to **Settings > System > Multiple users**.
2. Select an account to switch to.
3. Tap .

Method 2:

1. Swipe down from the top of the screen to open the Control center, and swipe down again to expand the shortcuts panel.
2. Tap .
3. Select an account to switch to.

Note

The illustration for Method 2 is for reference only. Options may vary by device model.

Remove a user or guest account

• Remove the account as the device owner

Method:

1. Sign in as the owner and go to **Settings > System > Multiple users**.
2. Select an account to remove and tap .

• Remove the account as a user or guest

Method:

1. Switch to the user or guest account.
2. Go to **Settings > System > Multiple users**.
3. Do any of the following:

- Tap  > **Remove [username] from this device** as a user.
- Tap **Exit guest mode** as a guest.

Note

1. The removal can't be undone.
2. After a user or guest account is removed, all apps and data in the space will be deleted.

Safety & emergency

 **Tip:** Whether the app is supported on a certain device and what features are available may vary by device model, carrier, and country/region. Please contact your distributor or service provider for more information.

Safety & emergency allows you to save and share emergency information, such as your medical information, SOS messages, crisis alerts, and wireless emergency alerts.

Set up emergency information

• Add medical information and emergency contacts

Use this option to add emergency contacts and medical information (such as blood type, allergies, or past medications).

Method:

1. Go to **Settings > Safety & emergency > Medical information/Emergency contacts**.
2. Follow the screen prompt to perform operations.
3. Add emergency contacts or medical information, such as blood type, allergies, or past medications.

• Enable Emergency SOS

Press the Power button quickly 3 times or more in an emergency to trigger an emergency action (such as calling emergency services, sharing information with emergency contacts, and recording an emergency video).

To set up an emergency action that will be triggered when you use Emergency SOS:

1. Go to **Settings > Safety & emergency > Emergency SOS**.
2. Tap **Start setup**.
3. Enable or disable the feature of playing a countdown audio alert.
4. Follow the screen prompt to set the operations to be performed by your device when you trigger an emergency SOS.

Note

Emergency SOS doesn't work when your device is in airplane mode or Battery Saver mode.

• Enable Crisis alerts

Use this option to get notified of public emergencies or local natural disasters.

Method:

1. Go to **Settings > Safety & emergency > Crisis alerts**.
2. Sign in to your account.
3. Enable **Crisis alerts**.

Enable Emergency location service

If **Use Emergency Location Service** (ELS) is enabled, and ELS works in your region, when you dial or text an emergency number, your phone will automatically send its location to first responders.

To enable this feature: Go to **Settings > Safety & emergency > Emergency Location Service**. To learn more about this feature, tap **Learn more**.

Wireless emergency alerts

Note

Your device may not support this option or some features of this option. To learn more, see Important Information and Warranty Card.

Use this option to manage the emergency alerts you have received, such as disaster alerts (Extremely Severe Alert, Severe Alert), test messages from telecommunication carriers or governmental agencies, threats to life and property, and kidnapping or abduction of children.

Method:

1. Go to **Settings > Safety & emergency > Wireless emergency alerts** and enable **Allow alerts**.
2. Perform one of the following operations:
 - To receive alerts about threats to life and property, enable **Extreme threats** or **Severe threats**.
 - To receive emergency announcements about child kidnapping or abduction, enable **AMBER alerts**.
 - To receive carrier tests and monthly tests from the safety alert system, enable **Test alerts**.
 - To view the history of emergency alerts, go to **Emergency alert history**.

• **Set up wireless emergency alerts**

Use this option to set the form of alerts and how often you want to receive alerts.

Method:

1. Go to **Settings > Safety & emergency > Wireless emergency alerts**.
2. Perform one of the following operations:
 - To enable or disable vibration when receiving alerts, toggle on or off **Vibrate**.
 - To select how often you want to receive alerts, tap **Alarm reminders** to select a frequency.

Device Maintenance

More maintenance options

For more information about the repair and maintenance of your device, refer to the paper manual included with your device.

Your device is powered by Android. To view the version information of your device, go to **Settings > About phone > Software information**.

To familiarize yourself with safety information, go to **Settings > About phone > Legal information > Safety information**.

If you encounter any issues during use, contact your network carrier or our after-sales service center. Go to **Settings > About phone > Customer service > Service centers** to find our after-sales service hotline.

Supported file formats

See the table below to learn about the file formats supported by your device:

Video recordings	MP4
Images	PNG, JPG, BMP, and GIF

Audio recordings	M4A
Music	MP3, OGG, WAV, MIDI, FLAC, M4A, AAC, AMR, AWB, and MP2
Videos	AVI, MP4, and 3GP

Instructions for USB connection

You can use your computer to manage images, videos, or documents on your phone in the following ways, depending on your computer type.

Connect your phone to a Windows computer with a USB cable

Method:

1. Connect your phone to your computer with a USB cable.
2. Pull down the notification bar on your phone.
3. Tap the "Charging this device via USB" notification.
4. Select **File transfer**.
5. Double-click on "This PC" on your computer to view the connected device.
6. Double-click to access the device and copy or manage files on your phone.

Note

1. To ensure the proper functioning of this feature, it is necessary to install Windows Media Player 11 or a higher version on Windows XP computers. This is not a prerequisite for Windows 7 or newer operating systems.
2. The button name may vary by computer.

Connect your phone to a Mac computer with a USB cable

Method:

1. Connect your phone to your computer with a USB cable.
2. Download the MTP tool on your computer.
3. Locate AndroidFileTransfer.dmg and double-click to open it.
4. Double-click the Android robot icon.
5. Copy or manage files on your phone.

Connect your phone to a Linux computer via Media Transfer Protocol File System (MTPFS)

Method:

1. Install the tool by running the command "sudo apt-get install mtp-tools mtpfs".
2. Create a new directory by running the command "sudo mkdir /media/mtp".
3. Modify the directory permissions by running the command "sudo chmod 755 /media/mtp".
4. Mount your phone by running the command "sudo mtpfs -o allow_other /media/mtp" to manage your files via File Manager.
5. Unmount your phone by running the command "sudo umount /media/mtp".

 **Note**

Throughout the setup process, ensure that the USB cable remains connected to your computer and phone. If the setup fails, restart your computer or try again.